

DOCUMENT RESUME

ED 360 178

SE 053 557

AUTHOR Vogt, Gregory L., Ed.; Wargo, Michael J., Ed.  
 TITLE Microgravity: A Teacher's Guide with Activities. Secondary Level.  
 INSTITUTION National Aeronautics and Space Administration, Washington, D.C.  
 REPORT NO EP-280  
 PUB DATE Jul 92  
 NOTE 64p.; Photographs will not reproduce clearly.  
 AVAILABLE FROM Education Division, NASA Headquarters, Code FET, Washington, DC 20277-2028.  
 PUB TYPE Guides - Classroom Use - Teaching Guides (For Teacher) (052)

EDRS PRICE MF01/PC03 Plus Postage.  
 DESCRIPTORS Experiential Learning; \*Gravity (Physics); Science Activities; \*Science Instruction; Scientific Concepts; Secondary Education; Secondary School Science; Space Sciences; \*Space Utilization  
 IDENTIFIERS \*Microgravity

ABSTRACT

A microgravity environment is one that will impart to an object a net acceleration that is small compared with that produced by Earth at its surface. In practice, such acceleration will range from about one percent of Earth's gravitational acceleration to better than one part in a million. this teacher's guide presents an introduction to microgravity, a microgravity primer discusses the fluid state, combustion science, materials science, biotechnology, and microgravity and space flight, and 12 microgravity activities (free fall demonstration; falling water, gravity and acceleration, inertial balance--2 parts, gravity driven fluid flow, candle flames, candle drop, contact angle, fiber pulling, crystal growth and microscopic observation of crystal growth). Each activity contains: the objective, background, procedure and materials needed. Some activities also includes suggested questions and further research. These activities used metric units of measure. A one-page glossary defines words used in microgravity research and 22 microgravity references are provided. The guide is amply illustrated with black and white photographs, diagrams, and drawings. (PR)

\*\*\*\*\*  
 \* Reproductions supplied by EDRS are the best that can be made \*  
 \* from the original document. \*  
 \*\*\*\*\*

ED360178

# Microgravity

A Teacher's Guide  
With Activities



ED053557

ERIC  
Full Text Provided by ERIC

U.S. DEPARTMENT OF EDUCATION  
Office of Educational Research and Improvement  
EDUCATIONAL RESOURCES INFORMATION  
CENTER (ERIC)

This document has been reproduced as received from the person or organization originating it.

Minor changes have been made to improve reproduction quality.

• Points of view or opinions stated in this document do not necessarily represent official OERI position or policy.

**BEST COPY AVAILABLE**

National Aeronautics and  
Space Administration

---

### **The Cover**

The National Aeronautics and Space Administration uses a variety of technologies to create microgravity environments for research. Pictured is the Space Shuttle Orbiter positioned with its tail pointed towards Earth to obtain the lowest possible gravity levels. In this orientation, called a gravity gradient attitude, the vehicle's position is maintained primarily by natural forces. This reduces the need for orbiter thruster firings that disturb acceleration-sensitive experiments.

---

SE

# Microgravity

**A Teacher's Guide With Activities**  
**Secondary Level**

**Microgravity Science and Applications Division**  
**Office of Space Science and Applications**

**Education Division**  
**Office of Human Resources and Education**

**National Aeronautics and Space Administration**



This publication may be reproduced.  
EP-280 July 1992

# Acknowledgments

The Microgravity Teacher's Guide was developed for the National Aeronautics and Space Administration with the guidance, support, and cooperation of many individuals and groups.

## **NASA Headquarters, Washington DC**

Office of Space-Science and Applications  
Microgravity Science and Applications Division  
Office of Human Resources and Education  
Education Division

## **Johnson Space Center, Houston, TX**

Education Working Group

## **Marshall Space Flight Center, Huntsville, AL**

Education Branch

### **Editors**

**Gregory L. Vogt, Ed.D.**  
Crew Educational Affairs Liaison  
Johnson Space Center

**Michael J. Wargo, Sc.D.**  
Visiting Senior Scientist  
Microgravity Science and Applications  
Division  
NASA Headquarters  
on leave from:  
Materials Processing Center  
Department of Materials Science and  
Engineering  
Massachusetts Institute of  
Technology

### **Production**

**Managing Editor**  
Cheryl A. Manning  
Technology and Evaluation Branch  
Education Division  
NASA Headquarters

**Cover Design**  
Another Color, Inc.

## Activity Contributors

**Free Fall Demonstrator**  
**Falling Water Cup**  
**Inertial Balance, Part 1**  
**Inertial Balance, Part 2**  
**Candle Drop**

Gregory L. Vogt, Ed.D.  
Crew Educational Affairs Liaison  
Johnson Space Center

**Gravity-Driven Fluid Flow**

Charles E. Bugg, Ph.D.  
Director  
Center for Macromolecular Crystallography  
University of Alabama at Birmingham

Craig D. Smith, Ph.D.  
Manager  
X-Ray Crystallography Laboratory  
Center for Macromolecular Crystallography  
University of Alabama at Birmingham

**Contact Angle**

Paul Concus Ph.D.  
Senior Scientist  
Lawrence Berkeley Laboratory  
Adjunct Professor of Mathematics  
University of California, Berkeley

Robert Finn, Ph.D.  
Professor of Mathematics  
Stanford University

**Gravity and Acceleration**

Richard DeLombard, M.S.E.E.  
Project Manager  
Space Acceleration Measurement System  
NASA Lewis Research Center

**Crystal Growth**

Roger L. Kroes, Ph.D.  
Researcher  
Microgravity Science Division  
NASA Marshall Space Flight Center

Donald A. Reiss, Ph.D.  
Researcher  
Microgravity Science Division  
NASA Marshall Space Flight Center

**Microscopic Observation of Crystal Growth**

David Mathiesen, Ph.D.  
Senior Research Associate  
Case Western Reserve University

**Fiber Pulling**

Robert J. Naumann, Ph.D.  
Professor  
Office of the Dean, College of Science  
The University of Alabama in Huntsville  
and  
Program Manager  
Consort Rocket Flights  
Consortium for Materials  
Development in Space  
The University of Alabama in Huntsville

**Candle Flames**

Howard D. Ross, Ph.D.  
Chief  
Microgravity Combustion Branch  
NASA Lewis Research Center

# Table of Contents

Acknowledgments	ii
<b>INTRODUCTION</b>	<b>1</b>
What Is Microgravity?	1
Gravity	2
Creating Microgravity	3
<b>MICROGRAVITY PRIMER</b>	<b>8</b>
The Fluid State	8
Combustion Science	11
Materials Science	12
Biotechnology	16
Microgravity and Space Flight	17
<b>ACTIVITIES</b>	<b>22</b>
Free Fall Demonstrator	23
Falling Water	25
Gravity and Acceleration	27
Inertial Balance, Part 1	29
Inertial Balance, Part 2	31
Gravity-Driven Fluid Flow	33
Candle Flames	35
Candle Drop	38
Contact Angle	40
Fiber Pulling	42
Crystal Growth	44
Microscopic Observation of Crystal Growth	47
<b>GLOSSARY</b>	<b>50</b>
<b>MICROGRAVITY REFERENCES</b>	<b>51</b>
<b>NASA EDUCATIONAL RESOURCES</b>	<b>52</b>



## Introduction

There are many reasons for space flight. Space flight carries scientific instruments, and sometimes humans, high above the ground, permitting us to see Earth as a planet and to study the complex interactions of atmosphere, oceans, land, energy, and living things. Space flight lofts scientific instruments above the filtering effects of the atmosphere, making the entire electromagnetic spectrum available and allowing us to see more clearly the distant planets, stars, and galaxies. Space flight permits us to travel directly to other worlds to see them close up and sample their compositions. Finally, space flight allows scientists to investigate living processes and the fundamental states of matter—solids, liquids, and gases—and the forces that affect them in a microgravity environment. The study of the states of matter and their interactions in microgravity is an exciting opportunity to expand the frontiers of science. Investigations include materials science, combustion, fluids, and biotechnology. Microgravity is the subject of this teacher's guide.

## What Is Microgravity?

The presence of Earth creates a gravitational field that acts to attract objects with a force inversely proportional to the square of the distance between the center of the object and the center of Earth. When measured on the surface of Earth, the acceleration of an object acted upon only by Earth's gravity is commonly referred to as one  $g$  or one Earth gravity. This acceleration is approximately 9.8 meters/second squared ( $m/s^2$ ).

The term *microgravity* ( $\mu g$ ) can be interpreted in a number of ways depending upon context. The prefix micro - ( $\mu$ ) is derived from the original Greek *mikros*, meaning "small." By this definition, a microgravity environment is one that will impart to an object a net acceleration small compared with that produced by Earth at its surface. In practice, such accelerations will range from about one percent of Earth's gravitational acceleration (aboard aircraft in parabolic flight) to better than one part in a million (for example, aboard Earth-orbiting free flyers).

Another common usage of micro- is found in quantitative systems of measurement, such as the metric system, where micro- means *one part in a million*. By this second definition, the acceleration imparted to an object in microgravity will be one-millionth ( $10^{-6}$ ) of that measured at Earth's surface.

The use of the term microgravity in this guide will correspond to the first definition: small gravity levels or low gravity. As we describe how low-acceleration environments can be produced, you will find that the fidelity (quality) of the microgravity environment will depend on the mechanism used to create it. For illustrative purposes only, we will provide a few simple quantitative examples using the second definition. The examples attempt to provide insight into what might be expected if the local acceleration environment would be reduced by six orders of magnitude from  $1g$  to  $10^{-6}g$ .

If you stepped off a roof that was five meters high, it would take you just one second to reach the ground. In a microgravity environment equal to one percent of Earth's gravitational pull, the same drop would take 10 seconds. In a microgravity environment equal to one-millionth of Earth's gravitational pull, the same drop would take 1,000 seconds or about 17 minutes!



Microgravity can be created in two ways. Because gravitational pull diminishes with distance, one way to create a microgravity environment is to travel away from Earth. To reach a point where Earth's gravitational pull is reduced to one-millionth of that at the surface, you would have to travel into space a distance of 6.37 million kilometers from Earth (almost 17 times farther away than the Moon). This approach is impractical, except for automated spacecraft, since humans have yet to travel farther away from Earth than the distance to the Moon. However, a more practical microgravity environment can be created through the act of free fall.

We will use a simple example to illustrate how free fall can achieve microgravity. Imagine riding in an elevator to the top floor of a very tall building. At the top, the cables supporting the car break, causing the car and you to fall to the ground. (In this example, we discount the effects of air friction on the falling car.) Since you and the elevator car are falling together, you will float inside the car. In other words, you and the elevator car are accelerating downward at the same rate. If a scale were present, your weight would not register because the scale would be falling too. (Figure 1)

## Gravity

Gravitational attraction is a fundamental property of matter that exists throughout the known universe. Physicists identify gravity as one of the four types of forces in the universe. The others are the strong and

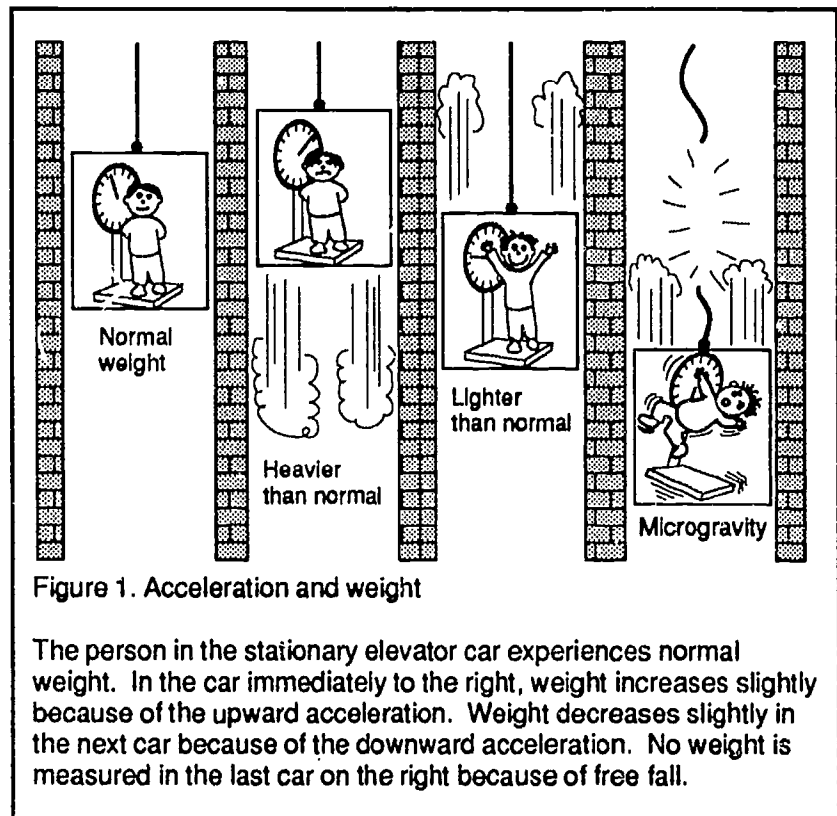

Figure 1. Acceleration and weight

The person in the stationary elevator car experiences normal weight. In the car immediately to the right, weight increases slightly because of the upward acceleration. Weight decreases slightly in the next car because of the downward acceleration. No weight is measured in the last car on the right because of free fall.

weak nuclear forces and the electromagnetic force.

More than 300 years ago the great English scientist Sir Isaac Newton published the important generalization that mathematically describes this universal force of gravity. Newton was the first to realize that gravity extends well beyond the domain of Earth. This realization was based on the first of three laws he had formulated to describe the motion of objects. Part of Newton's first law, the law of inertia, states that objects in motion travel in a straight line at a constant velocity unless acted upon by a net force. According to this law, the planets in space should travel in straight lines. However, as early as the time of Aristotle, the planets were known to travel on curved paths. Newton reasoned that the circular motions of the planets are the result of a net force acting upon each of them. That force, he concluded, is the same force that causes an apple to fall to the ground—gravity.

Newton's experimental research into the force of gravity resulted in his elegant mathematical statement that is known today as the **Law of Universal Gravitation**. According to Newton, every mass in the universe attracts every other mass. The attractive force between any two objects is directly proportional to the product of the two masses being measured and inversely proportional to the square of the distance separating them. If we let  $F$  represent this force,  $r$  the distance between the centers of the masses, and  $m_1$  and  $m_2$  the magnitude of the two masses, the relationship stated can be written symbolically as:

$$F \propto \frac{m_1 m_2}{r^2}$$

( $\propto$  is defined mathematically to mean "is proportional to.") From this relationship, we can see that the greater the masses of the attracting objects, the greater the force of attraction between them. We can also see that the farther apart the objects are from each other, the less the attraction. It is important to note the inverse square relationship with respect to distance. In other words, if the distance between the objects is doubled, the attraction between them is diminished by a factor of four, and if the distance is tripled, the attraction is only one-ninth as much.

Newton's Law of Universal Gravitation was later quantified by eighteenth-century English physicist Henry Cavendish who actually measured the gravitational force between two one-kilogram masses separated by a distance of one meter. This attraction was an extremely weak force, but its determination permitted the proportional relationship of Newton's law to be converted into an equation. This measurement yielded the *universal gravitational constant* or  $G$ .

### Deep In Space

The inverse square relationship, with respect to distance, of the Law of Gravitation can be used to determine how far to move a micro-gravity laboratory from Earth to achieve a  $10^{-6}g$  environment. Distance ( $r$ ) is measured between the centers of mass of the laboratory and of Earth. While the laboratory is still on Earth, the distance between their centers is 6,370 kilometers (equal to the approximate radius of Earth,  $r_e$ ). To achieve  $10^{-6}g$ , the laboratory has to be moved to a distance of 1,000 Earth radii. In the equation,  $r$  then becomes  $1,000 r_e$  or  $r = 6.37 \times 10^6 \text{ km}$ .

Cavendish determined that the value of  $G$  is 0.0000000000667 newton  $\text{m}^2/\text{kg}^2$  or  $6.67 \times 10^{-11} \text{ Nm}^2/\text{kg}^2$ . With  $G$  added to the equation, the Universal Law of Gravitation becomes:

$$F = G \frac{m_1 m_2}{r^2}$$

## Creating Microgravity

### Drop Towers and Tubes

In a practical sense, microgravity can be achieved with a number of technologies, each depending upon the act of free fall. Drop towers and drop tubes are high-tech versions of the elevator analogy presented in a previous section. The large version of these facilities is essentially a hole in the ground.

Drop towers accommodate large experiment packages, generally using a drop shield to contain the package and isolate the experiment from aerodynamic drag during free fall in the open environment.

NASA's Lewis Research Center in Cleveland, Ohio has a 145-meter drop tower facility that begins on the surface and descends into Earth like a mine shaft. The test section of the facility is 6.1 meters in diameter and 132 meters deep. Beneath the test section is a catch basin filled with polystyrene beads. The 132-meter drop creates a microgravity environment for a period of 5.2 seconds.

To begin a drop experiment, the experiment apparatus is placed in either a cylindrical or rectangular test vehicle that can carry experiment loads of up to 450 kilograms. The vehicle is suspended from a cap that encloses the upper end of the facility. Air is pumped out of the facility until a vacuum of  $10^{-2}$  torr is achieved. (Atmospheric pressure is 760 torr.) By doing so, the acceleration effects caused by aerodynamic drag on the vehicle are reduced to less than  $10^{-5}$  g. During the drop, cameras within the vehicle record the action and data is telemetered to recorders.

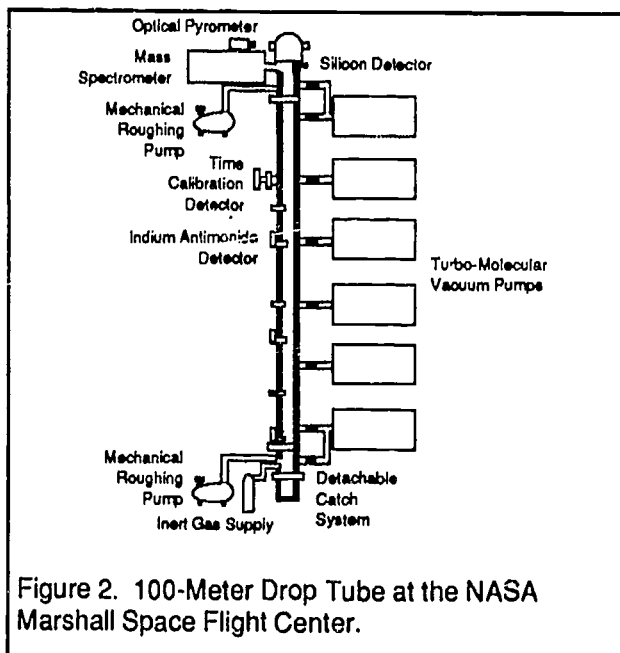

Figure 2. 100-Meter Drop Tube at the NASA Marshall Space Flight Center.

A smaller facility for microgravity research is located at the NASA Marshall Space Flight Center in Huntsville, Alabama. It is a 100-meter-high, 25.4-centimeter-diameter evacu-

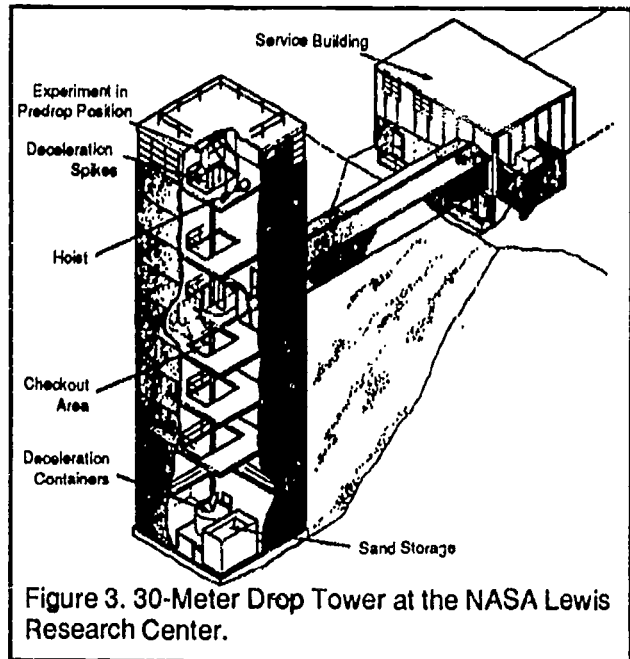

Figure 3. 30-Meter Drop Tower at the NASA Lewis Research Center.

ated drop tube that can achieve microgravity for periods of as long as 4.5 seconds. The upper end of the tube is fitted with a stainless steel bell jar. For solidification experiments, an electron bombardment or an electromagnetic levitator furnace is mounted inside the jar to melt the test samples. After the sample melts, drops are formed and fall through the tube to a detachable catch fixture at the bottom of the tube. (Figure 2.)

Additional drop facilities of different sizes and for different purposes are located at the NASA Field Centers and in other countries. A 490-meter-deep vertical mine shaft in Japan has been converted to a drop facility that can achieve a  $10^{-5}$ g environment for up to 11.7 seconds.

## Aircraft

Airplanes can achieve low-gravity for periods of about 25 seconds or longer. The NASA Johnson Space Center in Houston, Texas operates a KC-135 aircraft for astronaut training and conducting experiments. The plane is a commercial-sized transport jet (Boeing 707) with most of its passenger

seats removed. The walls are padded for protection of the people inside. Although airplanes cannot achieve microgravity conditions of as high quality as those produced in drop towers and drop tubes (since they are never completely in free fall and their drag forces are quite high), they do offer an important advantage over drop facilities—experimenters can ride along with their experiments.

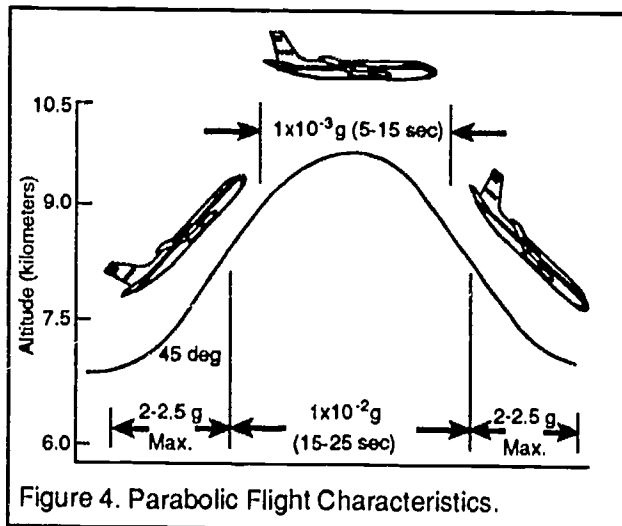

A typical flight lasts 2 to 3 hours and carries experiments and crewmembers to a beginning altitude about 7 km above sea level. The plane climbs rapidly at a 45-degree angle (pull up), traces a parabola (push-over), and then descends at a 45-degree angle (pull out). (Figure 4) During the pull up and pull out segments, crew and experiments experience between 2g and 2.5g. During the parabola, at altitudes ranging from 7.3 to 10.4 kilometers, net acceleration drops as low as  $10^{-3}$  g. On a typical flight, 40 parabolic trajectories are flown. The gut-wrenching sensations produced on the flight have earned the plane the nickname of "vomit comet."

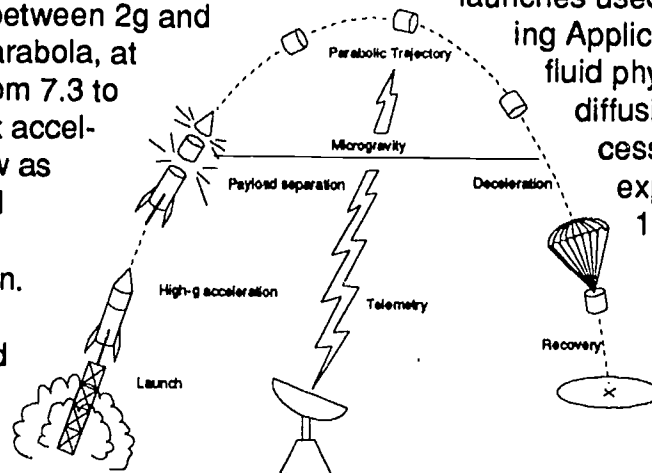
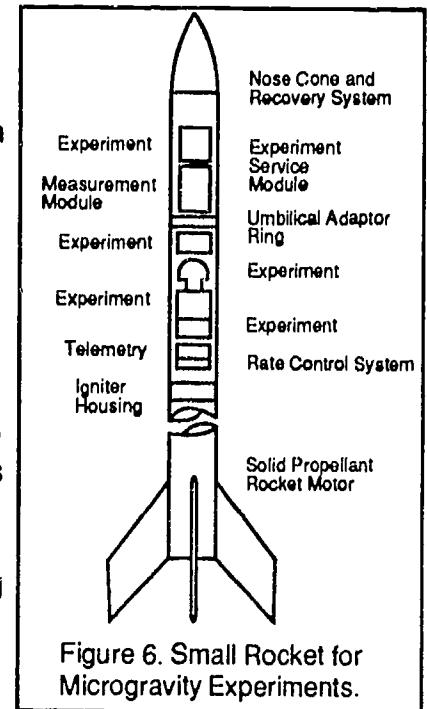

Figure 5. Rocket Parabolic Flight Profile.

NASA also operates a Learjet for low-gravity research out of the NASA Lewis Research Center. Flying on a trajectory similar to the one followed by the KC-135, the Learjet provides a low-acceleration environment of  $5 \times 10^{-2}$  g to  $75 \times 10^{-2}$  g for up to 20 seconds.



## Rockets

Small rockets provide a third technology for creating microgravity. A sounding rocket follows a suborbital trajectory and can produce several minutes of free fall. The period of free fall exists during its coast, after burn out, and before entering the atmosphere. Acceleration levels are usually at or below  $10^{-5}$ g. NASA has employed many different sounding rockets for microgravity experiments. The most comprehensive series of launches used SPAR (Space Processing Application Rocket) rockets for fluid physics, capillarity, liquid diffusion, containerless processing, and electrolysis experiments from 1975 to 1981. The SPAR could lift 300 kg payloads into free-fall parabolic trajectories lasting four to six minutes. (Figures 5, 6)



## Orbiting Spacecraft

Although airplanes, drop facilities, and small rockets can be used to establish a micro-gravity environment, all of these laboratories share a common problem. After a few seconds or minutes of low-g, Earth gets in the way and the free fall stops. In spite of this limitation, much can be learned about fluid dynamics and mixing, liquid-gas surface interactions, and crystallization and macromolecular structure. But to conduct longer term experiments (days, weeks, months, and years), it is necessary to travel into space and orbit Earth. Having more time available for experiments means that slower processes and more subtle effects can be investigated.

To see how it is possible to establish micro-gravity conditions for long periods of time, it is first necessary to understand what keeps a spacecraft in orbit. Ask any group of students or adults what keeps satellites and Space Shuttles in orbit and you will probably get a variety of answers. Two common answers are: "The rocket engines keep firing to hold it up." and "There is no gravity in space."

Although the first answer is theoretically possible, the path followed by the spacecraft would technically not be an orbit. Other than the altitude involved and the specific means of exerting an upward force, there would be little difference between a spacecraft with its engines constantly firing and an airplane flying around the world. In the case of the satellite, it would just not be possible to provide it with enough fuel to maintain its altitude for more than a few minutes.

The second answer is also wrong. In a previous section, we discussed that Isaac Newton proved that the circular paths of the planets through space was due to gravity's presence, not its absence.

Newton expanded on his conclusions about gravity and hypothesized how an artificial satellite could be made to orbit Earth. He envisioned a very tall mountain extending above Earth's atmosphere so that friction with the air would not be a factor. He then imagined a cannon at the top of that mountain firing cannonballs parallel to the ground. As each cannonball was fired, it was acted upon by two forces. One force, the explosion of the black powder, propelled the cannonball straight outward. If no other force were to act on the cannon ball, the shot would travel in a straight line and at a constant velocity. But Newton knew that a second force would act on the cannonball:

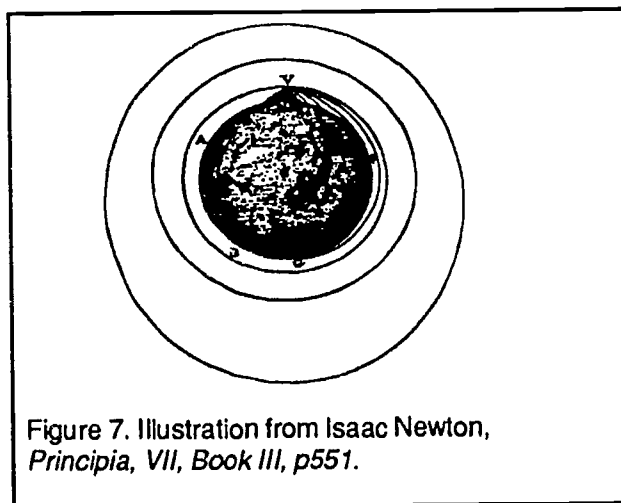

Figure 7. Illustration from Isaac Newton, *Principia*, VII, Book III, p551.

the presence of gravity would cause the path of the cannonball to bend into an arc ending at Earth's surface. (Figure 7)

Newton demonstrated how additional cannonballs would travel farther from the mountain if the cannon were loaded with more black powder each time it was fired. With each shot, the path would lengthen and soon, the cannonballs would disappear over the horizon. Eventually, if a cannonball were fired with enough energy, it would fall entirely around Earth and come back to its starting point. The cannonball would begin to orbit Earth. Provided no force other than gravity interfered with the cannonball's

### "Microgravity Room"

One of the common questions asked by visitors to the NASA Johnson Space Center in Houston, Texas is, "Where is the room where a button is pushed and gravity goes away so that astronauts float?" No such room exists because gravity can never be made to go away. The misconception comes from the television pictures that NASA takes of astronauts training in the KC-135 and from underwater training pictures. Astronauts scheduled to wear spacesuits for extravehicular activities

train in the Weightless Environment Training Facility (WET F). The WET F is a swimming pool large enough to hold a Space Shuttle payload bay mock-up and mock-ups of satellites and experiments. Since the astronauts' spacesuits are filled with air, heavy weights are added to the suits to achieve neutral buoyancy in the water. The facility provides an excellent simulation of what it is like to work in space with two exceptions: in the pool it is possible to swim with hand and leg motions, and if a hand tool is dropped, it falls to the bottom.

motion, it would continue circling Earth in that orbit.

This is how the Space Shuttle stays in orbit. It is launched in a trajectory that arcs above Earth so that the orbiter is traveling at the right speed to keep it falling while maintaining a constant altitude above the surface. For example, if the Shuttle climbs to a 320-kilometer-high orbit, it must travel at a speed of about 27,740 kilometers per hour to achieve a stable orbit. At that speed and altitude, the Shuttle's falling path will be parallel to the curvature of Earth. Because the Space Shuttle is free-falling around Earth and upper atmospheric friction is extremely low, a microgravity environment is established.

Orbiting spacecraft provide ideal laboratories for microgravity research. As on airplanes, scientists can fly with the experiments that are on the spacecraft. Because the experiments are tended, they do not have to be fully automatic in operation. A malfunction in an experiment conducted with a drop tower or small rocket means a loss of data or complete failure. In orbiting spacecraft, crewmembers can make repairs so that

there is little or no loss of data. They can also make on-orbit modifications in experiments to gather more diverse data.

Perhaps the greatest advantage of orbiting spacecraft for microgravity research is the amount of time during which microgravity conditions can be achieved. Experiments lasting for more than a week are possible with the Space Shuttle. When NASA's planned international Space Station *Freedom* is assembled and ready for use, the time available for experiments will stretch to months. Space Station *Freedom* will provide a manned microgravity laboratory facility unrivaled by any on Earth. (Figure 8)

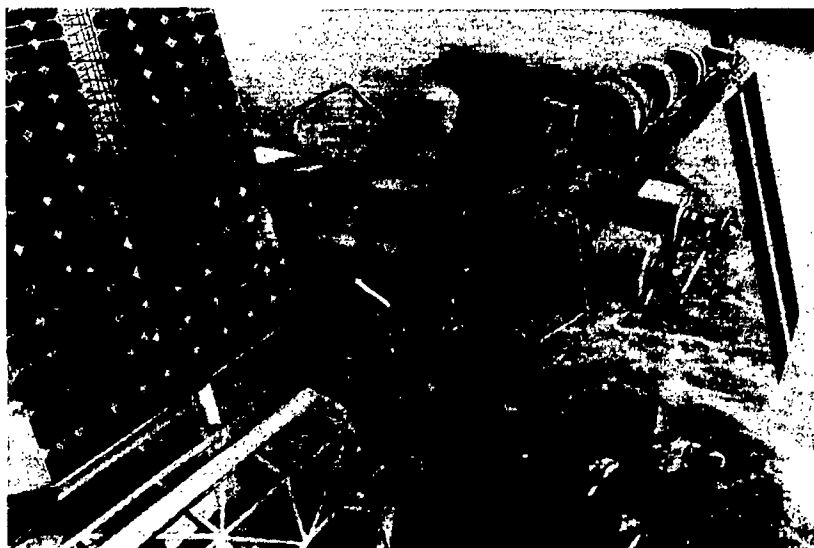

Figure 8. Space Station *Freedom*.



## Microgravity Primer

Gravity is a dominant factor in many chemical and physical processes on Earth.

- Heat applied to the bottom of a soup pot is conducted by the metal of the pot to the soup inside. The heated soup expands and becomes less dense than the soup above. It rises because cool, dense soup is pulled down by gravity, and the warm, less dense, soup rises to the top. A circulation pattern is produced that mixes the entire soup. This is called buoyancy-driven convection.
- Liquids of unequal density which do not interact chemically, like vinegar and oil, mix only temporarily when shaken vigorously together. Their different densities cause them to separate into two distinct layers. This is called sedimentation.
- Crystals and metal alloys contain defects and have properties which are directly and indirectly attributed to gravity-related effects. Convective flows such as those described above are present in the molten form of the material from which the solids are formed. As a result, some of the atoms and molecules making up the crystalline structure may be displaced from their intended positions. Dislocations, extra or missing half planes of atoms in the crystal structure, are one example of microscopic defects which create subtle, but important, distortions in the optical and electrical properties of the crystal.

Many basic processes are strongly influenced by gravity. For the scientific researcher, buoyancy-driven convection and sedimentation are significant phenomena because they have such a profound direct effect on the processes involved. They can also mask other phenomena that may be equally important but too subtle to be easily observed. If gravity's effects were eliminated, how would liquids of unequal densities mix? Could new alloys be formed? Could large crystals with precisely controlled crystalline and chemical perfection be grown? What would happen to the flame of a candle? There are many theories and experiments which predict the answers to these questions, but the only way to answer and fully understand these questions and a host of others is to effectively eliminate gravity as a factor. Drop towers, airplanes, sounding rockets, and the Space Shuttle make this possible, as will Space Station *Freedom* in a few years.

What are the subtle phenomena that gravity masks? What research will scientists pursue in microgravity?

## The Fluid State

To most of us, the word "fluid" brings to mind images of water and other liquids. But to a scientist, the word fluid means much more. A fluid is any liquid or gaseous material that flows and, in gravity, assumes the shape of the container it is in. Gases fill the whole container; liquids on Earth fill only the lower part of the container equal to the volume of the liquid.

Scientists are interested in fluids for a variety of reasons. Fluids are an important part of life processes, from the blood in our veins and arteries to the oxygen in the air. The properties of fluids make plumbing, automobiles, and even fluorescent lighting possible. Fluid mechanics describes many processes

that occur within the human body and also explains the flow of sap through plants. The preparation of materials often involves a fluid state that ultimately has a strong impact on the characteristics of the final product.

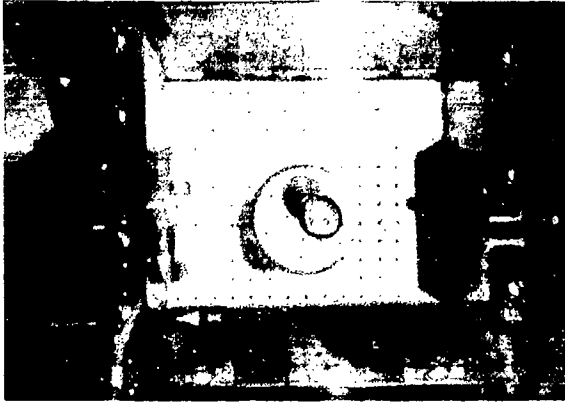

Figure 9. A liquid is manipulated by sound waves in the Drop Dynamics Module experiment on Spacelab 3. By using sound waves to position the drop, possible container wall contamination is eliminated.

Scientists gain increased insight into the properties and behavior of fluids by studying their movement or flow, the processes that occur within fluids, and the transformation between the different states of a fluid (liquid and gas) and the solid state. Studying these phenomena in microgravity allows the scientists to examine processes and conditions impossible to study when influenced by Earth's gravity. The knowledge gained can be used to improve fluid handling, materials processing, and many other areas in which fluids play a role. This knowledge can be applied not only on Earth, but also in space.

### Fluid Dynamics and Transport Phenomena

Fluid dynamics and transport phenomena are central to a wide range of physical, chemical and biological processes, many of which are technologically important in both Earth- and space-based applications. In this context, the term transport phenomena

refers to the different mechanisms by which energy and matter (e.g., atoms, molecules, particles, etc.) move. Gravity often introduces complexities which severely limit the fundamental understanding of a large number of these different transport mechanisms.

For example, buoyancy-driven flows, which arise from density differences in the fluid, often prevent the study of other important transport phenomena such as diffusion and surface tension-driven flows. Surface tension-driven flows are caused by differences in the temperature and/or chemical composition at the fluid surface. The fluid flows from areas where the surface tension is low to areas where it is high. Low gravity conditions can reduce by orders of magnitude the effects of buoyancy, sedimentation, and hydrostatic pressure, enabling observations and measurements which are difficult or impossible to obtain in a terrestrial laboratory. (Hydrostatic pressure is that pressure which is exerted on a portion of a column of fluid as a result of the weight of the fluid above it.)



Figure 10. During an experiment on Spacelab 3, a rotating liquid drop assumes a "dog bone" shape.

The systematic study of fluids under microgravity conditions holds the promise of refining existing theory or allowing the formulation of new theories to describe fluid



dynamics and transport phenomena. Such research promises to improve the understanding of those aspects of fluid dynamics and transport phenomena whose fundamental behavior is limited or affected by the influence of gravity. Several research areas contain promising opportunities for significant advancements through low-gravity experiments. These research areas include: capillary phenomena, multiphase flows and heat transfer, diffusive transport, magneto/electrohydrodynamics, colloids, and solid-fluid interface dynamics. These terms will be defined in their respective sections.

**Capillary Phenomena.** Capillarity describes the relative attraction of a fluid for a solid surface compared with its self-attraction. A typical example of capillary action is the rise of sap in plants. Research in capillary phenomena is a particularly fertile area for low-gravity experiments because of the increased importance of capillary forces as the effects of gravity are reduced. Such circumstances are always encountered in multiphase fluid systems where there is a liquid-liquid, liquid-vapor, or liquid-solid interface. Surface tension-driven flows also become increasingly important as the effects of gravity are reduced and can dramatically affect other phenomena such as the interactions and coalescence of drops and bubbles.

**Multiphase Flow and Heat Transfer.** Capillary forces also play a significant role in multiphase flow and heat transfer, particularly under reduced-gravity conditions. It is important to be able to accurately predict the rate at which heat will be transported between two-phase mixtures and solid surfaces—for example, as a liquid and gas flow through a pipe. Of course, it is equally important to be able to predict the heat exchange between the two different fluid phases. Furthermore, when the rate of transferring heat to or from the multiphase

fluid system reaches a sufficient level, the liquids or gases present may change phase. That is, the liquid may boil (heat entering the liquid), the liquid may freeze (heat leaving the liquid), or the gas may condense (heat leaving the gas). While the phase change processes of melting and solidification under reduced-gravity conditions have been studied extensively—due to their importance in materials processing—similar progress has not been made in understanding the process of boiling and condensation. Although these processes are broadly affected by gravity, improvements in the fundamental understanding of such effects have been hindered by the lack of experimental data.

**Diffusive Transport.** Diffusion is a mechanism by which atoms and molecules move through solids, liquids, and gases. The constituent atoms and molecules spread through the medium (in this case, liquids and gases) due primarily to differences in concentration, though a difference in temperature can be an important secondary effect in microgravity. Much of the important research in this area involves studies where several types of diffusion occur simultaneously. The significant reduction in



Figure 11. Space Shuttle *Atlantis* crewmembers John E. Blaha and Shannon W. Lucid prepare liquids in a middeck experiment on polymer membrane processing.

buoyancy-driven convection that occurs in a free-fall orbit may provide more accurate measurements and insights into these complicated transport processes.

**Magneto/Electrohydrodynamics.** The research areas of magnetohydrodynamics and electrohydrodynamics involve the study of the effects of magnetic and electric fields on mass transport (atoms, molecules, and particles) in fluids. Low velocity fluid flows, such as those found in poor electrical conductors in a magnetic field, are particularly interesting. The most promising low-gravity research in magneto/electrohydrodynamics deals with the study of effects normally obscured by buoyancy-driven convection. Under normal gravity conditions, buoyancy-driven convection can be caused by the fluid becoming heated due to its electrical resistance as it interacts with electric and magnetic fields. The heating of a material caused by the flow of electric current through it is known as Joule heating. Studies in space may improve techniques for manipulating multiphase systems such as those containing fluid globules and separation processes such as electrophoresis, which uses applied electric fields to separate biological materials.

**Colloids.** Colloids are suspensions of finely divided solids or liquids in gaseous or liquid fluids. Colloidal dispersions of liquids in gases are commonly called aerosols. Smoke is an example of fine solid particles dispersed in gases. Gels are colloidal mixtures of liquids and solids where the solids have linked together to form a continuous network. Research interest in the colloids area includes the study of formation and growth phenomena during phase transitions—e.g., when liquids change to solids. Research in microgravity may allow measurement of large scale aggregation or clustering phenomena without the complication of the different sedimentation rates due

to size and particle distortion caused by settling and fluid flows that occur under normal gravity.

**Solid-Fluid Interface Dynamics.** A better understanding of solid-fluid interface dynamics, how the boundary between a solid and a fluid acquires and maintains its shape, can contribute to improved materials processing applications. The morphological (shape) stability of an advancing solid-fluid interface is a key problem in such materials processing activities as the growth of homogeneous single crystals. Experiments in low-gravity, with significant reductions in buoyancy-driven convection, could allow mass transport in the fluid phase by diffusion only. Such conditions are particularly attractive for testing existing theories for processes and for providing unique data to advance theories for chemical systems where the interface interactions strongly depend on direction and shape.

## Combustion Science

There is ample practical motivation for advancing combustion science. It plays a key role in energy transformation, air pollution, surface-based transportation, spacecraft and aircraft propulsion, global environmental heating, materials processing, and hazardous waste disposal through incineration. These and many other applications of combustion science have great importance in national economic, social, political, and military issues. While the combustion process is clearly beneficial, it is also extremely dangerous when not controlled. Enormous numbers of lives and valuable property are destroyed each year by fires and explosions. Two accidents involving U.S. spacecraft in the Apollo program were attributed to gaps in the available knowledge of combustion fundamentals under special circumstances. Planning for a permanent human presence in space demands the develop-

ment of fundamental combustion science in reduced gravity to either eliminate spacecraft fires as a practical possibility or to develop powerful strategies to detect and extinguish incipient spacecraft fires. Advances in understanding the combustion process will also benefit fire safety in aircraft, industry, and the home.

The recently developed capability to perform experiments in microgravity may prove to be a vital tool in completing our understanding of combustion processes. From a fundamental viewpoint, the most prominent feature that distinguishes combustion processes from processes involving fluid flow is the large temperature variations which invariably exist in a reacting flow. These large temperature variations are caused by highly-localized, highly-exothermic heat release from the chemical reactions characteristic of combustion processes. For example, the temperature of a reactive mixture can increase from the unreacted, ambient state of about 25° C (around room temperature) to the totally reacted state of over 2750° C. These large temperature differences lead to correspondingly large density differences and hence, to the potential existence of strong buoyancy-driven fluid flows. These flows can modify, mask, or even dominate the convective-diffusive transport processes that mix and heat the fuel and oxidant reactants before chemical reactions can be initiated. For combustion in two-phase flows, the presence of gravity introduces additional complications. Here particles and droplets can settle, causing stratification in the mixture. The effects of surface tension on the shape and motion of the surface of a large body of liquid fuel can also be modified due to the presence of buoyancy-driven flows.

Gravity can introduce a degree of asymmetry in an otherwise symmetrical phenomenon. For example, combustion of a gas-

eous jet injected horizontally quickly loses its symmetry along its long axis as the hot flame plume gradually tilts 'upward.' The fluid transport processes in these situations are inherently multi-dimensional and highly complex.

Important as it is, buoyancy is frequently neglected in the mathematical analysis of combustion phenomena either for mathematical simplicity or to facilitate identification of the characteristics of those controlling processes which do not depend on gravity. Such implications, however, can render direct comparison between theory and experiment either difficult or meaningless. It also weakens the feedback process between theoretical and experimental developments which is so essential in the advancement of science.

## Materials Science

The current materials science program is characterized by a balance of fundamental research and applications-oriented investigations. The goal of the materials science program is to utilize the unique characteristics of the space environment to further our understanding of the processes by which materials are produced, and to further our understanding of their properties, some of which may be produced only in the space environment. The program attempts to advance the fundamental understanding of the physics associated with phase changes. This includes solidification, crystal growth, condensation from the vapor, etc. Materials science also seeks explanations for previous space-based research results for which no clear explanations exist. Research activities are supported which investigate materials processing techniques unique to the microgravity environment, or which, when studied in microgravity, may yield unique information with terrestrial applications.

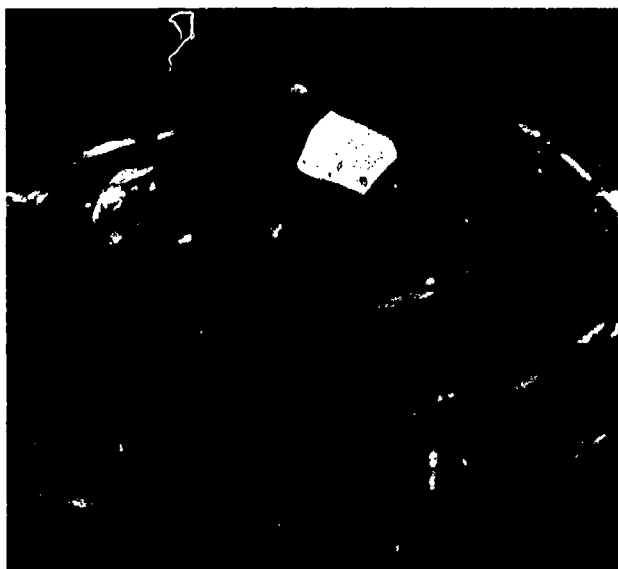

Crystal of mercuric iodide grown by gas vapor deposition during a Spacelab experiment.

### Microgravity Materials Science Background

The orbital space environment offers the researcher two unique features which are attainable on Earth to only a very limited extent. These are 'free fall' with the attendant reduced gravity environment and a high quality vacuum of vast extent. Suborbital conditions of free fall are limited to less than 10 seconds in drop towers, less than 25 seconds during aircraft maneuvers, and less than 15 minutes during rocket flights. The quality of the microgravity environment of these various ground-based options ranges from  $10^{-2}$  g to  $10^{-5}$  g. With the Space Shuttle, this duration has been extended to days and weeks—with Space Station and free flyers, to months and years.

In a reduced gravity environment, relative motion is slowed in direct proportion to the reduction in net acceleration. At  $10^{-6}$  g, particles suspended in a fluid will sediment a million times more slowly than they do on Earth. Thermal and solutal convection is much less vigorous in microgravity than it is on Earth, and in some cases seems to become a secondary transport mechanism.

Both thermal and solutal convection are examples of buoyancy-driven convection. In the first case, the difference in density is caused by a difference in temperature; in the second case, the density difference is caused by the changing chemical composition of the liquid. As indicated previously, buoyancy-induced convection can be suppressed in a low-gravity environment. For many materials science investigations, this experimental condition is extremely interesting because it allows us to study purely diffusive behavior in systems for which conditions of constant density are difficult or impossible to create or for which experiments in 'convection-free' capillaries lead to ambiguous results.

To date, much of the space-based research has focused on this unique condition with respect to processing materials which are particularly susceptible to compositional nonuniformities resulting from convective or sedimentation effects. The process by which compositionally nonuniform material is produced is referred to as segregation. Some of the first microgravity experiments in metallurgy were attempts to form fine dispersions of metal particles in another metal when the two liquid metals are immiscible. Unexpected separation of the two metals seen in several low gravity experiments in this area has given us new insight into the mechanisms behind dispersion formation (fine droplets of one metal dispersed in another metal), but a complete model including the role of critical wetting, droplet migration, and particle pushing has yet to be formulated.

There is no dispute that gravity-driven convective flows in crystal growth processes affect mass transport. This has been demonstrated for crystals growing from the melt as well as from the vapor. The distribution of components in a multicomponent system has a marked influence on the resultant



properties of a material (for example, the distribution of selenium atoms in the important electronic material, GaAs). Consequently, space processing of materials has always carried with it the hope of reducing convective flows during crystal growth to such a degree that crystallization would proceed in a purely diffusive environment for mass transport, to result in crystals with uniform composition. However, the expectation of space-processed, perfectly homogeneous materials with improved properties has yet to be realized. Future experiments on crystal growth will be directed at a wide variety of electronic materials such as GaAs, triglycine sulfate,  $\text{HgI}_2$ ,  $\text{HgCdTe}$  (from the vapor),  $\text{CdTe}$ ,  $\text{HgZnTe}$ ,  $\text{PbBr}_2$  and  $\text{PbSnTe}$ . In addition, the research of our international collaborators will include  $\text{InGaAs}$ ,  $\text{InSb}$ ,  $\text{SiAsTe}$ ,  $\text{Si}$ ,  $\text{GaInSb}$ ,  $\text{InP}$ , and  $\text{Ge}$ .

In order to understand crystal growth processes in microgravity, it is essential that many aspects of these phase transformations (e.g., liquid to solid, vapor to solid) be understood. This includes a thorough knowledge of the behavior of fluids (gases and liquids), a fundamental understanding of the crystallization process, and a sufficient data base of thermophysical information (e.g., thermal conductivities, diffusion coefficients, etc.) with which various theories can be tested. It may be necessary to measure some of these quantities in microgravity, as ground-based data may be either subject to error or even impossible to generate.

The flight research focussing on fundamental problems in solidification reflects this broad scope of activity, ranging from studies of morphological stability in transparent organic systems (which serve as excellent experimental models of metallic systems) to studies of metals solidifying without the confinement of a container.

## Microgravity Materials Science Research

The field of materials science is extremely broad. It encompasses essentially all materials, concerns itself with the synthesis, production, and further processing of these materials, and deals with matter both on an atomistic level and on a bulk level. Although materials science addresses a myriad of problems, there are fundamental scientific issues common to all of its subdisciplines. These include evolution of the microscopic structure of the materials, transport phenomena, and the determination of relevant thermophysical properties. Interface morphology and stability, and macro- and micro-segregation (the distribution of a component on the microscopic and macroscopic scales) represent ongoing challenges.

Historically, the materials science community has segmented itself on the basis of materials (composites, steels, polymers), on the basis of specific processes (casting, solidification, welding), and on the basis of fundamental physical phenomena (property measurements, diffusion studies, study of morphological stability).

Materials. The materials of interest to the microgravity materials science discipline have traditionally been categorized as electronic, metallic, glass, and ceramic. However, recent space experiments have broadened this traditional categorization to include polymeric materials as well. Additional classes of materials which may benefit greatly from being studied in a low gravity environment are: advanced composites, electronic and opto-electronic crystals, high performance metal alloys, and superconductors (high temperature and low temperature, metallic, ceramic, and organic). For their scientific and technological significance, there is also strong interest in composites, fibers, foams, and films, whatever their

constitution, when the requirement for experiments in low gravity can be clearly defined.

**Processes.** Because the manifestation of gravitational effects is greatest in the presence of a fluid, the following processes are of considerable importance: solidification, crystallization from solution, and condensation from the vapor. These processes have been the subject of numerous low-gravity investigations for many years. Scientifically interesting, and potentially important technologically, are

the processes of welding and electrodeposition. Unique welding experiments in Skylab and recent low-gravity electrodeposition experiments in sounding rockets have produced unexplained results. The ultra-high vacuum and nearly infinite pumping rate of space offer researchers the possibility of pursuing ultra-high vacuum processing of materials and, perhaps, ultra-purification.

Of primary importance is the utility of the space environment in helping an investigator understand the process of interest. Can a low-gravity environment be used to our advantage in elucidating important scientific information concerning these processes? Are there processes that are truly unique to the microgravity environment?

**Phenomena.** On a macroscale, convective motion, induced by residual accelerations or other effects, persists in the liquid or

gaseous fluid from which a material is either solidifying, crystallizing, or condensing. On a microscale, the arrangement of atoms or molecules in a solid occurs at a boundary between the 'frozen' solid and the convective fluid. The interaction between these convective flows and the resultant solid

formation needs much greater understanding. A critical issue facing space-based materials science research is the response of experiments to more or less random acceleration environments within a manned spacecraft. Are compositional inhomogeneities and

other major defects results of such random accelerations? What is the tolerable acceleration level for a given experiment? Are there ways of increasing experimental tolerance to a given level of acceleration? The answers to these questions will not only enhance our understanding of fundamental phenomena but also provide the foundations upon which useful space-based laboratories for materials science can be designed.

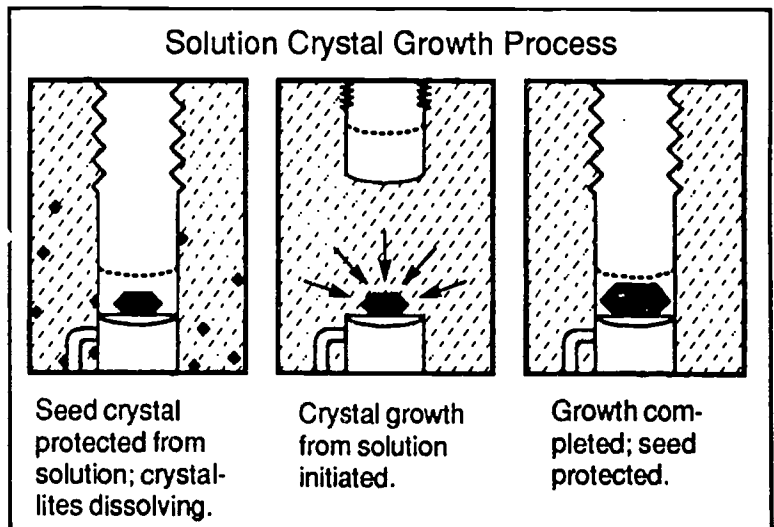
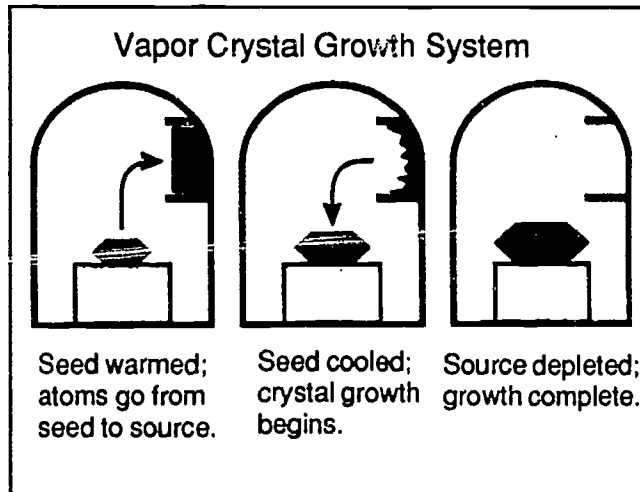

### Shot Towers

The idea of using "free fall" or microgravity for research and materials processing is not a new one. American colonists used free fall to produce lead shot for their weapons. This process, patented by British merchant William Watts in 1782, involved pouring molten lead through a sieve at the top of a 15- to 30-meter-tall tower. As the lead fell, the drops became nearly perfect solid spheres that were quenched upon landing in a pool of water at the foot of the tower. Free fall produced shot superior to that produced by other methods. Scientists now explore both the phenomenon of microgravity and the use of microgravity for materials research.

Since the pioneering diffusion experiments conducted on Spacelab D-1 concerning self-diffusion in tin, there has been a heightened awareness of the need to measure the appropriate thermophysical parameters of the material under investigation. It hardly suffices, in many instances, to conduct an experiment in a diffusion-controlled environment, if the analysis of the experiment uses ground-based thermophysical data which may be in error. To avoid ambiguity in the interpretation of space experiments, it may be necessary to generate data on selected materials parameters from actual low-gravity experiments. This area of research is particularly important to the entire materials science field.

## Biotechnology

The biotechnology program is comprised of three areas of research: protein crystal growth, mammalian cell culture, and fundamentals of biotechnology.

### Protein Crystal Growth

The protein crystal growth program is directed to: (1) contribute to the advance in knowledge of biological molecular structures through the utilization of the space environment to help overcome a principal obstacle in the determination of molecular structures—the growth of crystals suitable for analysis by X-ray diffraction; and (2) advance the understanding of the fundamental mechanisms by which large biological molecules form crystals. The program seeks to develop these objectives through a coordinated effort of space- and ground-based research, whereby ground-based research attempts to use and explain the results of flight research, and flight research incorporates the knowledge gained from ground-based research and prior flight experience to develop refined techniques and objectives for subsequent experiments.



Space-grown canavalin protein crystals.

### Mammalian Cell Culture

The mammalian cell culture program seeks to develop an understanding sufficient to assess the scientific value of mammalian cells and tissues cultured under low-gravity conditions, where mechanical stresses on growing tissues and cells can be held to

very low levels. Preliminary evidence from the culture of a variety of suspended cells in rotating vessels has shown indications of increased viability and tissue differentiation. These results suggest that better control of the stresses exerted on cells or tissues can play an important role in the culture of *in vitro* tumor models, normal tissues, and other challenging problems.

### **Fundamentals of Biotechnology**

This area of research is concerned with the identification and understanding of biotechnological processes and biophysical phenomena which can be advantageously studied in the space environment. Potential research areas include molecular and cellular aggregation, the behavior of electrically-driven flows, and capillary and surface phenomena, as applied uniquely to biological systems.

### **Background of Protein Crystal Growth Flight Experiments**

The first protein crystal growth experiments in space were conducted on the Spacelab-1 mission in 1983 where crystals of hen egg white lysozyme and beta-galactosidase were grown. In the mid-1980's, a hand-held device for protein crystal growth experiments was developed and flown on four Shuttle missions as a precursor to the Vapor Diffusion Apparatus (VDA) - Refrigerator/Incubator Module experiments later flown in the Shuttle middeck. Despite having encountered a number of minor technical difficulties on several flights, the project has enjoyed significant success. These include the growth of crystals to sizes and degrees of perfection beyond any ground-based efforts, and the formation of crystals in scientifically useful forms which had not been previously encountered in similar ground-based experiments. Though the physics of protein crystal growth are under-

stood in broad terms, there is currently no agreement on a detailed mechanistic explanation for these phenomena.

## **Microgravity and Space Flight**

Until the mid-20th century, gravity was an unavoidable aspect of research and technology. During the latter half of the century, although drop towers could be used to reduce the effects of gravity, the extremely short periods of time they provided (<6 seconds) severely restricted the type of research that could be performed.

Initial research centered around solving space flight problems created by microgravity. How do you get the proper amount of fuel to a rocket engine in space or water to an astronaut on a spacewalk? The brief periods of microgravity available in drop towers at the NASA Lewis Research Center and NASA Marshall Space Flight Center were sufficient to answer these basic questions and to develop the pressurized systems and other new technologies needed to cope with this new environment. But, they still were not sufficient to investigate the host of other questions that were raised by having gravity as an experimental variable.

The first long-term opportunities to explore the microgravity environment and conduct research relatively free of the effects of gravity came during the latter stages of NASA's first great era of discovery. The Apollo program presented scientists with the chance to test ideas for using the space environment for research in materials, fluid, and life sciences. The current NASA microgravity program had its beginning in the experiments conducted in the later flights of Apollo, the Apollo-Soyuz Test Project, and onboard Skylab, America's first space station.



Preliminary microgravity experiments conducted during the 1970's were severely constrained, either by the relatively low power levels and volume available on the Apollo spacecraft, or by the low number of flight opportunities provided by Skylab. These experiments, as simple as they were, often stimulated new insights in the roles of fluid and heat flows in materials processing. Much of our understanding of the physics underlying semiconductor crystal growth, for example, can be traced back to research initiated with Skylab.



Skylab.

Since the early 1980's, NASA has sent crews and payloads into orbit on board the Space Shuttle. The Space Shuttle has given microgravity scientists an opportunity to bring their experiments to low-Earth orbit on a more regular basis. The Shuttle introduced significant new capabilities for microgravity research: larger, scientifically trained crews; a major increase in payload, volume, mass, and available power; and the return to Earth of all instruments, samples, and data. The Spacelab module, developed for the Shuttle by the European Space Agency,

gives scientists a laboratory with enough power and volume to conduct a limited range of sophisticated microgravity experiments in space.

Use of the Shuttle for microgravity research began in 1982, on its third flight, and continues today on many missions. In fact, most Shuttle missions carry microgravity experiments as secondary payloads.

### Spacelab-1, November 1983

The Spacelab-1 mission was launched in November 1983. Over ten days, the seven crewmembers carried out a broad variety of space science experiments, including research in microgravity sciences, astrophysics, space plasma physics, and Earth observations.

Although the primary purpose of the mission was to test the operations of the complex Spacelab and its subsystems, the 71 microgravity experiments, conducted using instruments from the European Space Agency, produced many interesting and provocative results. One investigator used the travelling heater method to grow a crystal of gallium antimonide doped with tellurium (a compound useful for making electronic devices). Due to the absence of gravity-driven convection, the space-grown crystal had a far more uniform distribution of tellurium than could be achieved on Earth. A second investigator used molten tin to study diffusion in low gravity—research that can improve our understanding of the behavior of molten metals. A German investigator grew protein crystals that were significantly better than those grown from the same starting materials on the ground. These crystals were analyzed using X-rays to determine the structure of the protein that was grown.

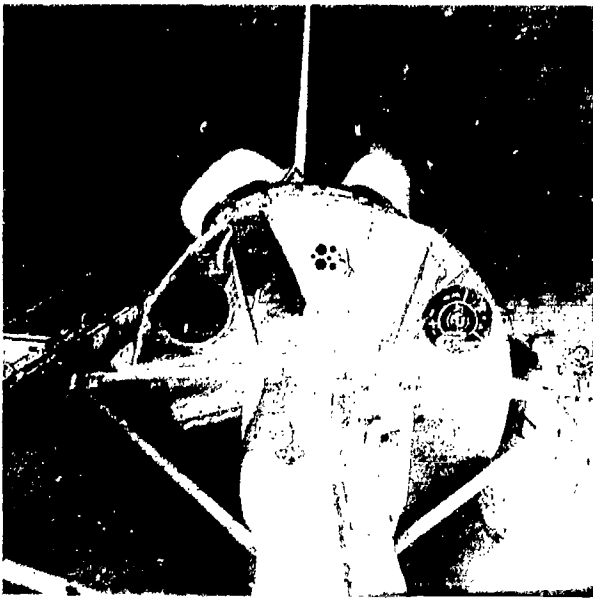

Spacelab 1 in payload bay of Shuttle Orbiter *Columbia*.

### Spacelab-3, April 1985

Another Shuttle mission using the Spacelab module was Spacelab-3, which flew in April 1985. SL-3 was the first mission to include U.S.-developed microgravity research instruments in the Spacelab. One of these instruments supported an experiment to study the growth of crystals of mercury iodide—a material of significant interest for use as a sensitive detector of X-rays and gamma rays. The experiment produced a crystal of mercury iodide grown at a rate much higher than that achievable on the ground. Despite the high rate of growth and relatively short growth time available, the resulting crystal was as good as the best crystal grown in the Earth-based laboratory. Another U.S. experiment consisted of a series of tests on fluid behavior using a spherical test cell. The microgravity environment allowed the researcher to use the test cell to mimic the behavior of the atmosphere over a large part of Earth's surface. Results from this experiment have been used to improve numerical models of our atmosphere.

### Spacelab D-1, October 1985

In October 1985, six months after the flight of SL-3, NASA launched a Spacelab mission sponsored by the Federal Republic of Germany, designated Spacelab-D1. This mission included a significant number of sophisticated microgravity materials and fluid science experiments. American and German scientists conducted experiments to synthesize high quality semiconductor crystals useful in infrared detectors and lasers. These crystals had improved properties and were more uniform in composition than their Earth-grown counterparts. Researchers also successfully measured critical properties of molten alloys. On Earth, convection-induced disturbances make such measurements impossible.

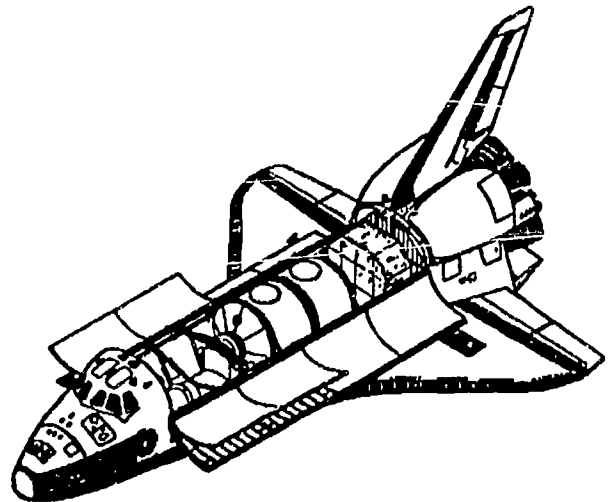

Spacelab long module in Orbiter payload bay.

### Spacelab Life Sciences-1, June 1991

The Spacelab Life Sciences-1 mission, flown in June 1991, was the first Spacelab mission dedicated to life sciences research. Mission experiments were aimed at trying to answer many important questions regarding the functioning of the human body in microgravity and its readaptation to the normal environment on Earth. Ten major investigations probed autonomic cardiovascular

controls, cardiovascular adaptation to microgravity, vestibular functions, pulmonary function, protein metabolism, mineral loss, and fluid-electrolyte regulation.

### **International Microgravity Laboratory-1, January 1992**

More than 220 scientists from the United States and 14 other countries contributed to the experiments flown on the first International Microgravity Laboratory in January 1992. Forty experiments in life and materials sciences were conducted by the crew which included payload specialists from Canada and the European Space Agency. Life sciences experiments probed the space motion sickness problem that many astronauts feel in microgravity, plant growth, and

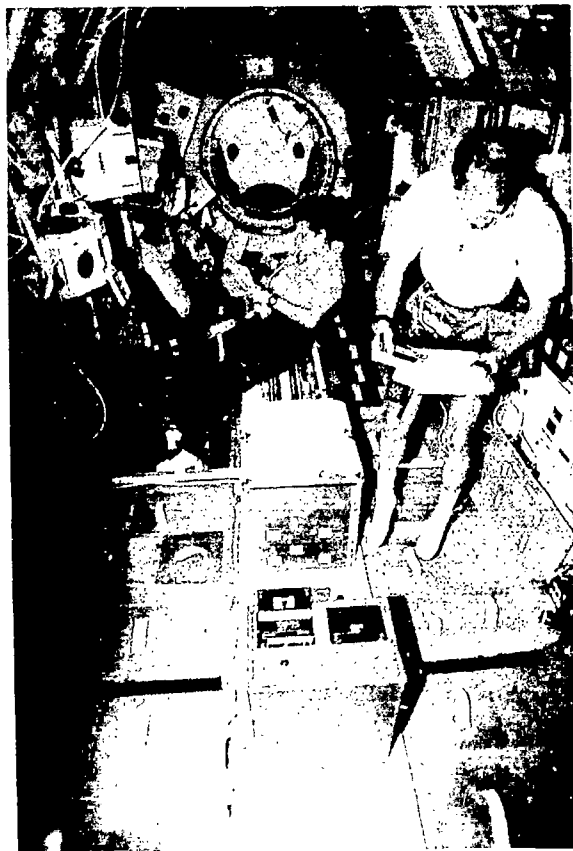

IML-1 crewmembers Roberta L. Bondar and Norman E. Thagard operate microgravity experiments inside of Spacelab.

cell separation. Materials science experiments concentrated on crystallization, casting and solidification technology, and critical point observations.

### **United States Microgravity Laboratory - 1, June 1992**

In 1987, the NASA Microgravity Materials Science Assessment Task Force called for a series of United States Microgravity Laboratory missions ". . . in order to develop a comprehensive program which would accommodate both U.S. research needs and Space Station development." The specific objectives of USML-1 were 1) to conduct scientific and technological investigations in materials, fluids, combustion, and biological processes; 2) to establish U.S. preeminence in microgravity research; 3) to form a basis for evolution into future Spacelab and Space Station missions; and 4) to explore potential applications of space for commercial products and processes.

The first United States Microgravity Laboratory (USML-1) was the longest Shuttle flight to date—14 days. Over thirty investigations comprised the payload, covering five basic areas: fluid dynamics, crystal growth, combustion science, biological science, and technology demonstrations.

The mission was an unqualified operational success in all of the areas listed above, with the crew conducting what became known as a "dress rehearsal" for Space Station *Freedom*. For example, a flexible glovebox, which provided an extra level of safety, was attached to the Crystal Growth Furnace. The furnace was then opened, previously processed samples were removed and an additional sample was inserted. This enabled another three experiments to be conducted. (Two other unprocessed samples were already in the furnace.)

Small candles were burned in an enclosed, safe environment. The results were similar (though much longer lived) to what can be seen by conducting the experiment in free fall, here on Earth. (See *Activity #8, Candle Drop*, in the Activities section of this teacher's guide.) The candles burned for about 45-60 seconds in the microgravity of continuous free fall aboard the Space Shuttle *Columbia*.

Surface tension controlled the shape of fluid surfaces in ways that confirmed theoretical predictions. Preliminary results indicate that the dynamics of rotating drops of silicone oil also conformed to theoretical predictions. Results of this kind are significant in that they illustrate an important part of the scientific method: hypotheses are formed, and experiments are conducted to test them.

The crew of scientist astronauts in the spacelab played an important role in maximizing the science return from this mission. They were able to look first hand at how well crystal growth solutions were mixed. The start-up process for growing protein crystals was examined and modified by the crew. Samples were reconfigured by hand to permit solutions to be completely injected into the experiment chamber. These are just a few examples of how the scientists in space worked with the scientists on the ground to get the most from each experiment.

The flight of the first United States Microgravity Laboratory marked the beginning of a new era in microgravity research.

### **Secondary Objectives**

In addition to Spacelab flights, NASA frequently flies microgravity experiments in the Space Shuttle middeck, in the cargo bay, and in the Get-Away-Special (GAS) canisters. Since 1988, NASA has built on the results of

the first Spacelab mission by growing crystals of many different kinds of proteins on the Shuttle middeck, including several sets of space-grown protein crystals that are substantially better than Earth-grown crystals of the same materials. Medical and agricultural researchers hope to use information from these protein crystals to improve their understanding of how the proteins function.

Research conducted in the Shuttle middeck has also led to the first space product: tiny spheres of latex that are significantly more uniform in size than those produced on the ground. These precision latex spheres are so uniform that they are sold by the National Institute of Standards and Technology (NIST) as a reference standard for calibrating devices such as electron microscopes and particle counters.

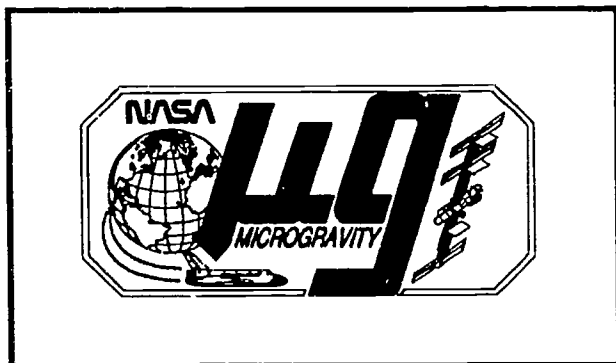

# Activities

## Activity List

Activity 1	Free Fall Demonstrator
Activity 2	Falling Water
Activity 3	Gravity and Acceleration
Activity 4	Inertial Balance, Part 1
Activity 5	Inertial Balance, Part 2
Activity 6	Gravity-Driven Fluid Flow
Activity 7	Candle Flames
Activity 8	Candle Drop
Activity 9	Contact Angle
Activity 10	Fiber Pulling
Activity 11	Crystal Growth
Activity 12	Microscopic Observation of Crystal Growth

### A Note on Measurement

These activities use metric units of measure. In a few exceptions, notably within the "materials needed" lists, English units have been listed. In the United States, metric-sized parts, such as screws, wood stock, and pipe are not as accessible as their English equivalents. Therefore, English units have been used to facilitate obtaining required materials.



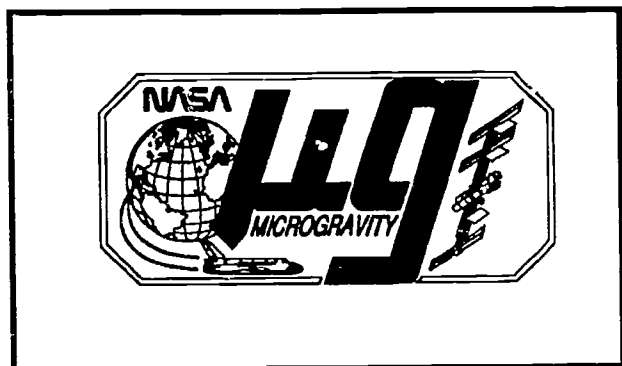

## Activity 1

# Free Fall Demonstrator

## OBJECTIVE:

To demonstrate that free fall eliminates the local effects of gravity

## BACKGROUND:

Microgravity conditions can be created in a number of ways. Amusement park customers feel a second or two of low-gravity on certain high-performance rides. Springboard divers experience low-gravity from the moment they leave the board until they hit the water. NASA achieves several seconds of microgravity with drop towers and drop tubes. Longer periods, from 25 seconds to a minute, can be achieved in airplanes following parabolic trajectories. Microgravity conditions lasting several minutes are possible using unmanned sounding rockets. The longest periods of microgravity are achieved with orbiting spacecraft.

The free fall demonstrator in this activity is an ideal device for classroom demonstrations on the effect of low-gravity. When stationary, the lead fishing weight stretches the rubber band so that the weight hangs near the bottom of the frame. When the frame is dropped, the whole apparatus goes into free fall, so the weight (the force of gravity) of the sinker becomes nearly zero. The stretched rubber bands then have no force to counteract their tension, so they pull the sinker, with the pin, up toward the balloon, causing it to pop. (In fact, initially the sinker's acceleration toward the balloon will

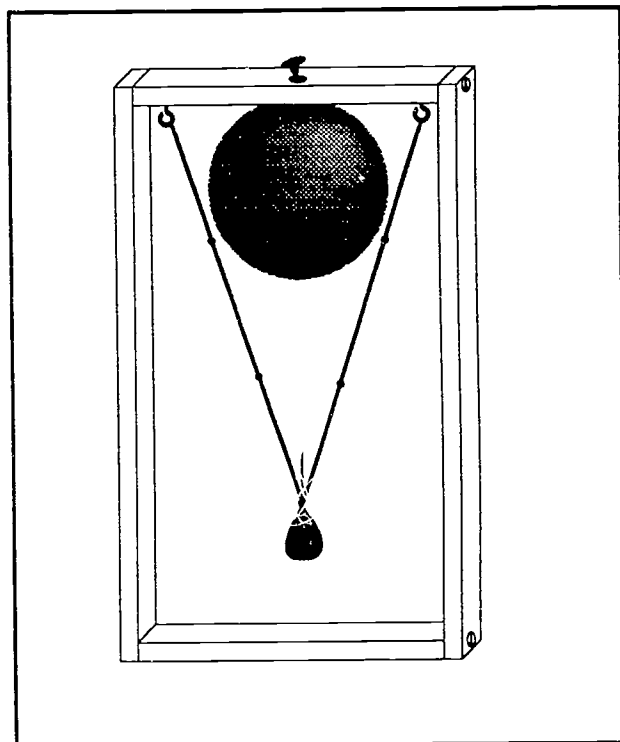

be at  $9.8 \text{ m/s}^2$ . Before the frame was dropped, tension in the rubber bands compensated for gravity on the sinker, so the force from that tension will accelerate the sinker at the same rate that gravity would.) If a second frame, with string instead of rubber bands supporting the weight, is used for comparison, the pin will not puncture the balloon as the device falls.

The demonstration works best when students are asked to predict what will happen when the frame is dropped. Will the balloon pop? If so, when will it pop? If your school has videotape equipment, you may wish to videotape the demonstration and use the slow motion controls on the playback machine to determine more precisely when the balloon popped.

**MATERIALS NEEDED:**

2 pieces of wood 16x2x1 in.  
 2 pieces of wood 10x2x1 in.  
 4 wood screws (#8 or #10 by 2 in.)  
 Glue  
 2 screw eyes  
 4-6 rubber bands  
 1 3-oz fishing sinker or 3 1-oz. fishing sinkers (taped together)  
 Long sewing pin or needle  
 Small round balloons  
 Short piece of string.  
 Drill, 1/2 in. bit, and bit for piloting holes for wood screws  
 Screwdriver  
 Pillow or chair cushion  
 (Optional - Make a second frame with string supporting the sinker.)

**PROCEDURE:**

- Step 1.** Assemble the supporting frame as shown in the diagram. Be sure to drill pilot holes for the screws and glue the frame pieces before screwing them together.
- Step 2.** Drill a 1/2 inch-diameter hole through the center of the top of the frame. Be sure the hole is free of splinters.
- Step 3.** Screw the two screw eyes into the underside of the top of the frame as shown in the diagram. (Before doing so, check to see that the metal gap at the eye is wide enough to slip a rubber band over it. If not, use pliers to spread the gap slightly.)

- Step 4.** Loop three rubber bands together and then loop one end through the metal loop of the fishing sinker(s).
- Step 5.** Follow the same procedure with the other three rubber bands. The fishing weight should hang downward like a swing, near the bottom of the frame. If the weight hangs near the top, the rubber bands are too strong. Replace them with thinner rubber bands.
- Step 6.** Attach the pin or needle, with the point upward, to the metal loop of the fishing weight. It may be possible to slip it through the rubber band loops to hold it in place. If not, use a small amount of tape or glue to hold it.
- Step 7.** Inflate the balloon, and tie off the nozzle with a short length of string. Thread the string through the hole and pull the balloon nozzle through. If the balloon nozzle does not remain in the hole, use the string to tie it there.
- Step 8.** Place a pillow or cushion on the floor. Raise the demonstrator at least 6 feet off the floor. Do not permit the weight to swing. Drop the entire unit onto the cushion. The balloon will pop almost immediately after release.

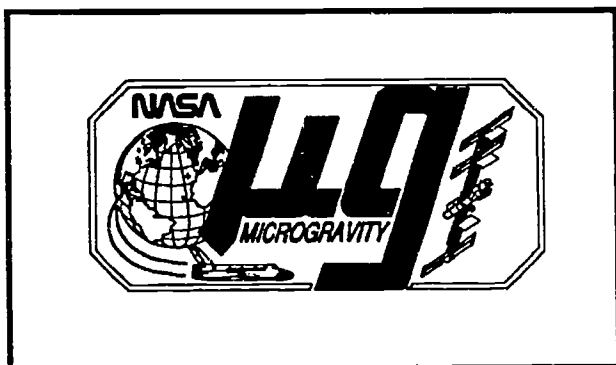

## Activity 2

# Falling Water

## OBJECTIVE:

To demonstrate that free fall eliminates the local effects of gravity

## BACKGROUND:

Weight is a property that is produced by gravitational force. An object at rest on Earth will weigh only one-sixth as much on the Moon because of the lower gravitational force there. That same object will weigh almost three times as much on Jupiter because of the giant planet's greater gravitational attraction. The apparent weight of the object can also change on Earth simply by changing its acceleration. If the object is placed on a fast elevator accelerating upward, its apparent weight would increase. However, if that same elevator were accelerating downward, the object's apparent weight would decrease. Finally, if that elevator were accelerating downward at the same rate as a freely falling object, the object's apparent weight would diminish to near zero.

Free fall is the way scientists create microgravity for their research. Various techniques, including drop towers, airplanes, sounding rockets, and orbiting spacecraft, achieve different degrees of perfection in matching the actual acceleration of a free-falling object.

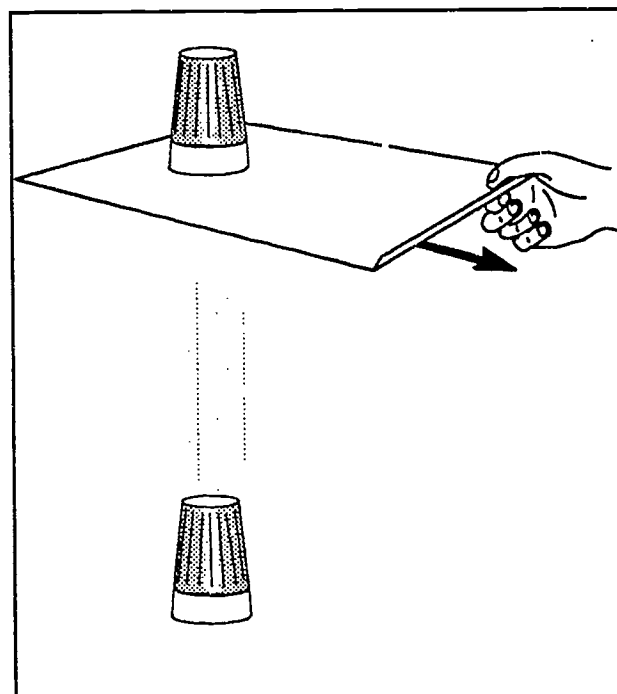

In this demonstration, a water-filled cup is inverted and dropped. Before release, the forces on the cup and water (their weight, caused by Earth's gravity) are counteracted by the cookie sheet. On release, if no horizontal forces are exerted on the cup when the sheet is removed, the only forces acting (neglecting air) are those of gravity. Since Galileo demonstrated that all objects accelerate similarly in Earth's gravity, the cup and water move together. Consequently, the water remains in the cup throughout the entire fall.

To make this demonstration possible, two additional scientific principles are involved. The cup is first filled with water. A cookie sheet is placed over the cup's mouth, and the sheet and the cup are



**MATERIALS NEEDED:**

Plastic drinking cup  
 Cookie sheet (with at least one edge without a rim)  
 Soda pop can (empty)  
 Sharp nail  
 Catch basin (large pail, waste basket)  
 Water  
 Chair or step-ladder (optional)  
 Towels

inverted together. Air pressure and surface tension forces keep the water from seeping out of the cup. Next, the cookie sheet is pulled away quickly, like the old trick of removing a table cloth from under a set of dishes. The inertia of the cup and water resists the movement of the cookie sheet so that both are momentarily suspended in air. The inverted cup and the water inside fall together.

**PROCEDURE:**

- Step 1.** Place the catch basin in the center of an open area in the classroom.
- Step 2.** Fill the cup with water.
- Step 3.** Place the cookie sheet over the opening of the cup. Hold the cup tight to the cookie sheet while inverting the sheet and cup.
- Step 4.** Hold the cookie sheet and cup high above the catch basin. You may wish to stand on a sturdy table or climb on a step-ladder to raise the cup higher.
- Step 5.** While holding the cookie sheet level, slowly slide the cup to the edge of the cookie sheet.
- Step 6.** Observe what happens.
- Step 7.** Refill the cup with water and invert it on the cookie sheet.

**Step 8.** Quickly pull the cookie sheet straight out from under the cup.

**Step 9.** Observe the fall of the cup and water.

**Step 10.** If your school has videotape equipment, you may wish to tape the activity and replay the fall using slow motion or pause controls to study the action at various points of the fall.

**FOR FURTHER RESEARCH:**

1. As an alternate or a supportive activity, punch a small hole near the bottom of an empty soda pop can. Fill the can with water and seal the hole with your thumb. Position the can over a catch basin and remove your thumb. Observe the water stream. Toss the can through the air to a second catch basin. Try not to make the can tumble or spin in flight. Observe what happens to the water stream. The flight of the can is a good demonstration of the parabolic trajectory followed by NASA's KC-135. (Note: Recycle the can when you are through.)
2. Why should you avoid tumbling or spinning the can?
3. Drop the can while standing on a chair, desk, or ladder. Compare the results with 1.

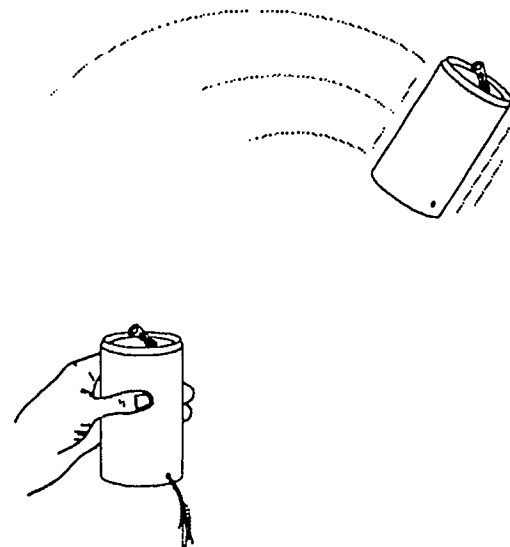

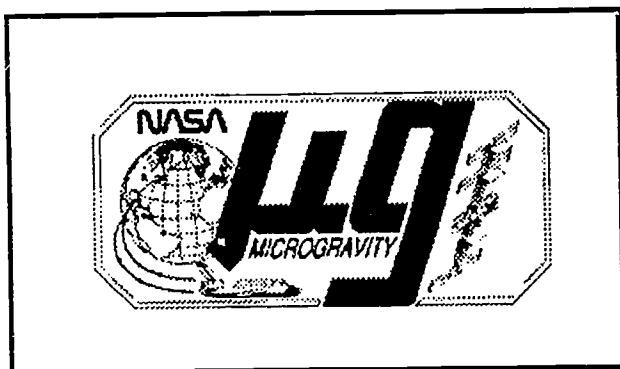

## Activity 3

# Gravity and Acceleration

## OBJECTIVE:

To use a plasma sheet to observe acceleration forces that are experienced on board a space vehicle

## BACKGROUND:

The accelerations experienced on board a space vehicle during flight are vector quantities resulting from forces acting on the vehicle and the equipment. These accelerations have many sources, such as residual gravity, orbiter rotation, vibration from equipment, and crew activity. The equivalent acceleration vector at any one spot in the orbiter is a combination of many different sources and is thus a very complex vector quantity changing over time. The magnitude and direction of the vector is highly dependent on the activities occurring at any time. The accelerations also depend on what has happened in the recent past due to the structural response (e.g., flexing and relaxing) of the vehicle to some activities, such as thruster firing, etc.

On the other hand, the gravity experienced on Earth is a relatively stable acceleration vector quantity because of the dominating large acceleration toward Earth's center. Some activities, such as earthquakes and subsurface magma movements and altitude changes, may perturb local gravitational acceleration.

Gravity and artificial accelerations may be investigated and demonstrated

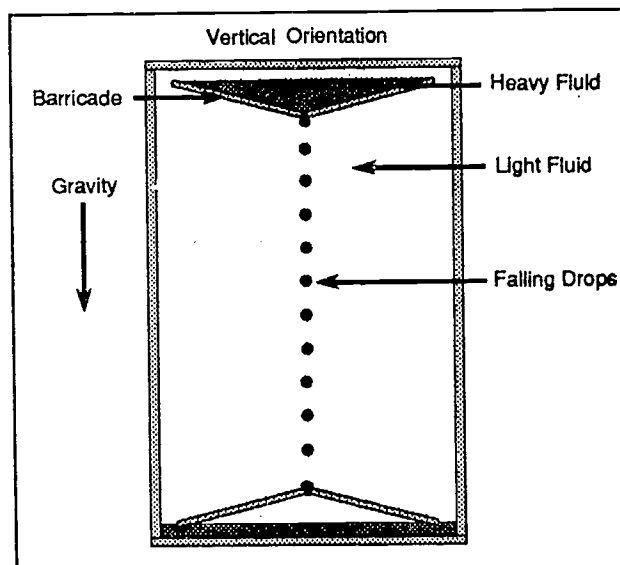

visually by using a common toy available in many toy, novelty, and museum stores. The toy consists of a clear, flat, plastic box with two liquids of different densities inside. By changing the orientation of the box, droplets of one liquid will pour through the other to the bottom. For the purposes of this activity, the toy will be referred to as a *plasma sheet*.

## PROCEDURE:

- Step 1.** Lay the plasma sheet on its flat side on the stage of an overhead projector. Project the action inside the sheet on a screen for the entire class to observe. The colored liquids will settle into a dispersed pattern across the sheet.
- Step 2.** Raise one end of the sheet slightly to add a new component to the acceleration vector, and support it

**MATERIALS NEEDED:**

Plasma sheet toy  
Record turntable  
File cards  
Overhead projector  
Slide projector  
Projection screen

by placing a one-centimeter-thick pile of file cards under the raised end. Observe the movement of the fluids inside.

- Step 3.** Raise the end of the plasma sheet further and support it with another stack of cards. Again, observe the movements of the fluids.
- Step 4.** Aim the slide projector at the screen. Project a white beam of light at the screen. Stand the plasma sheet on its end in front of the projected beam to cast shadows. Observe the action of the falling liquids.
- Step 5.** Lay the plasma sheet on its flat side so that the colored liquid will accumulate in the center. Hold the sheet horizontally in your hand and, using your arm as a pendulum, swing the sheet from side to side several times. Observe what happens to the liquid.
- Step 6.** Lay the plasma sheet on its flat side on a phonograph record turntable. Start the turntable moving. Observe what happens to the liquid.

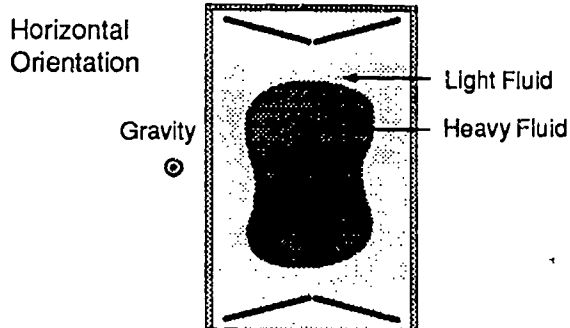
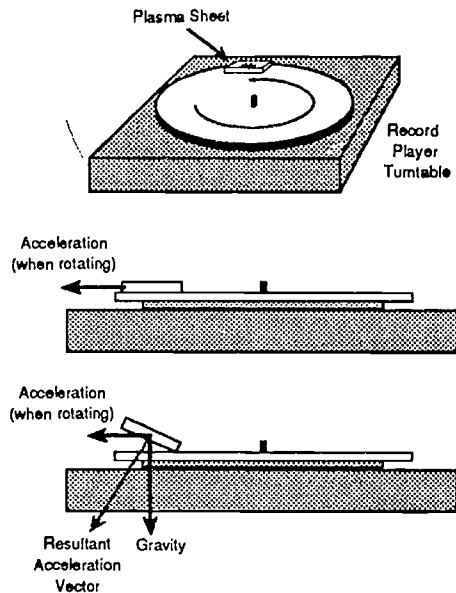
**Rotational Acceleration Demonstration**

- Step 7.** Experiment with elevating the outer edge of the plasma sheet on the turntable until the acceleration vector produces a distribution of liquid similar to the dispersion observed in step 1.

**QUESTIONS:**

1. What implications do the plasma sheet demonstrations have for scientific researchers interested in investigating microgravity phenomena? How will Space Shuttle orbiter thruster firings and crew movements affect sensitive experiments?
2. How might acceleration vectors be reduced on the Space Shuttle? Would there be any advantage to the quality of microgravity research by conducting that research on Space Station *Freedom*?

**FOR FURTHER RESEARCH:**

1. Investigate how scientists measure acceleration vectors in their research.
2. Challenge the students to design a simple and rugged accelerometer that could be used to measure accelerations experienced in a package sent through the U.S. Mail.

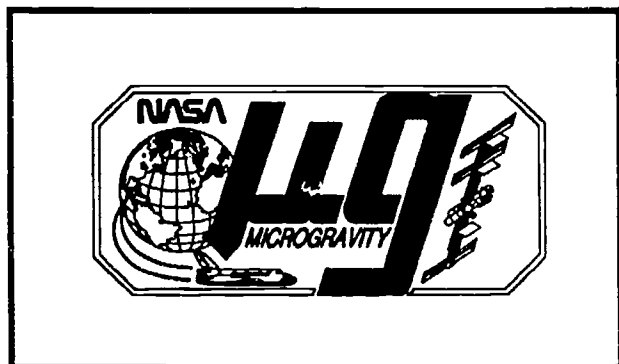

## Activity 4

# Inertial Balance Part 1

### OBJECTIVE:

To demonstrate how mass can be measured in microgravity

### BACKGROUND:

The microgravity environment of an orbiting Space Shuttle or space station presents many research challenges for scientists. One of these challenges is the measurement of the mass of experiment samples and subjects. In life sciences research, for example, nutrition studies of astronauts in orbit may require daily monitoring of an astronaut's mass. In materials science research, it may be desirable to determine how the mass of a growing crystal changes daily. To meet these needs, an accurate measurement of mass is vital.

On Earth, mass measurement is simple. The samples and subjects are measured on a scale or beam balance. Calibrated springs in scales are compressed to derive the needed measurement. Beam balances measure an unknown mass by comparison to a known mass (kilogram weights). In both of these methods, the measurement is dependent upon the force produced by Earth's gravitational pull.

In space, neither method works because of the free fall condition of orbit. However, a third method for mass measurement is possible using the principle of inertia. Inertia is the property of matter that

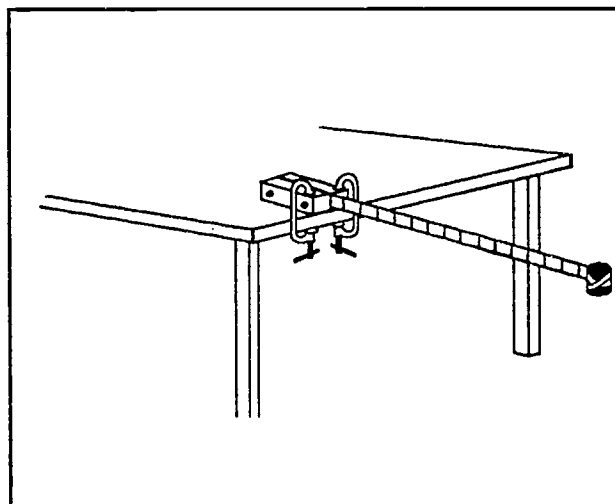

causes it to resist acceleration. The amount of resistance to acceleration is directly proportional to the object's mass.

To measure mass in space, scientists use an inertial balance. An inertial balance is a spring device that vibrates the subject or sample being measured. The frequency of the vibration will vary with the mass of the object and the stiffness of the spring (in this diagram, the yard stick). For a given spring, an object with greater mass will vibrate more slowly than an object with less mass. The object to be measured is placed in the inertial balance, and a spring mechanism starts the vibration. The time needed to complete a given number of cycles is measured, and the mass of the object is calculated.

### PROCEDURE:

**Step 1.** Using the drill and bit to make the necessary holes, bolt two blocks of wood to the opposite sides of one end of the steel yard stick.

**MATERIALS NEEDED:**

Metal yardstick\*  
 2 C-clamps\*  
 Plastic 35mm film canister  
 Pillow foam (cut in plug shape to fit canister)  
 Masking tape  
 Wood blocks  
 2 bolts and nuts  
 Drill and bit  
 Coins or other objects to be measured  
 Graph paper, ruler, and pencil  
 Pennies and nickels  
 Stopwatch  
 \*Available from hardware store

- Step 2.** Tape an empty plastic film canister to the opposite end of the yardstick. Insert the foam plug.
- Step 3.** Anchor the wood block end of the inertial balance to a table top with C-clamps. The other end of the yardstick should be free to swing from side to side.
- Step 4.** Calibrate the inertial balance by placing objects of known mass (pennies) in the sample bucket (canister with foam plug). Begin with just the bucket. Push the end of the yardstick to one side and release it. Using a stopwatch or clock with a second hand, time how long it takes for the stick to complete 25 cycles.
- Step 5.** Plot the time on a graph above the value of 0. (See sample graph.)
- Step 6.** Place a single penny in the bucket. Use the foam to anchor the penny so that it does not move inside the bucket. Any movement of the sample mass will result in an error (oscillations of the mass can cause a damping effect). Measure the time needed to complete 25 cycles.

Plot the number over the value of 1 on the graph.

- Step 7.** Repeat the procedure for different numbers of pennies up to 10.
- Step 8.** Draw a curve on the graph through the plotted points.
- Step 9.** Place a nickel (object of unknown mass) in the bucket and measure the time required for 25 cycles. Find the horizontal line that represents the number of vibrations for the nickel. Follow the line until it intersects the graph plot. Follow a vertical line from that point on the plot to the penny scale at the bottom of the graph. This will give the mass of the nickel in "penny" units.

**Note:** This activity makes use of pennies as a standard of measurement. If you have access to a metric beam balance, you can calibrate the inertial balance into metric mass measurements using the weights as the standards.

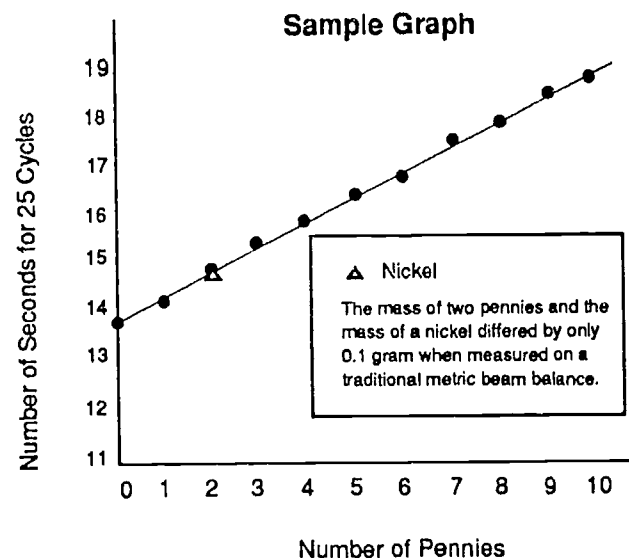
**QUESTIONS:**

1. Does the length of the ruler make a difference in the results?
2. What are some of the possible sources of error in measuring the cycles?
3. Why is it important to use foam to anchor the pennies in the bucket?

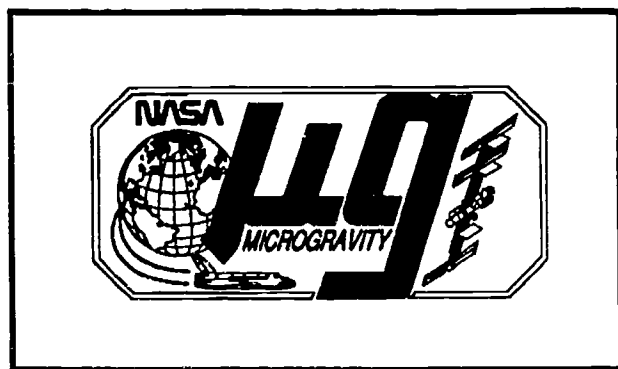

## Activity 5

# Inertial Balance

## Part 2

**OBJECTIVE:**

To feel how inertia effects acceleration

**BACKGROUND:**

The inertial balance in Part 1 of this activity operates by virtue of the fundamental property of all matter that causes it to resist changes in motion. In the case of the inertial balance, the resistance to motion is referred to as *rotational inertia*. This is because the yardstick pivots at the point on the table where it is anchored and the bucket swings through an arc. Unlike linear motion, the placement of mass in rotational movements is important. Rotational inertia increases with increasing distance from the axis of rotation.

The inertial balance in Part 1 uses a metal yardstick as a spring. The bucket for holding samples is located at the end opposite the axis of rotation. Moving the bucket closer to the axis will make a stiffer spring that increases the sensitivity of the device.

The relationship of the placement of mass to distance from the axis of rotation is easily demonstrated with a set of inertia rods. The rods are identical in appearance and mass and even have identical centers of mass. Yet, one rod is easy to rotate and the other is difficult. The secret of the rods is the location of the mass inside of them. In one rod, the mass is close to the axis of rotation, and in the other, the mass is

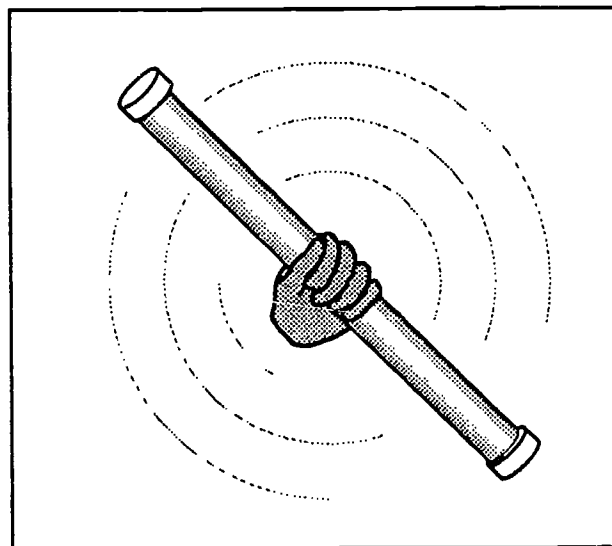

concentrated at the ends of the rod. Students will be able to feel the difference in rotational inertia between the two rods as they try to rotate them.

**PROCEDURE:**

- Step 1.** Using a saw, cut the PVC tube in half. Smooth out the ends, and check to see that the caps fit the ends.
- Step 2.** Squeeze a generous amount of silicone rubber sealant into the end of one of the tubes. Slide the nipple into the tube. Using the dowel rod, push the nipple to the middle of the tube. Add sealant to the other end of the tube and insert the second nipple. Position both nipples so that they are touching each other and straddling the center of the tube. Set the tube aside to dry.



**MATERIALS NEEDED:**

PVC 3/4 in. water pipe  
 (about 1.5 to 2 m long)  
 4 iron pipe nipples  
 (sized to fit inside PVC pipe)  
 4 PVC caps to fit water pipe  
 Silicone rubber sealant  
 Scale or beam balance  
 Saw  
 Very fine sand paper  
 1/2 in. dowel rod

**Step 3.** Squeeze some sealant into the ends of the second tube. Push the remaining pipe nipples into the ends of the tubes until the ends of the nipples are flush with the tube ends. Be sure there is enough compound to cement the nipples in place. Set the tube aside to dry.

**Step 4.** When the sealant of both tubes is dry, check to see that the nipples are firmly cemented in place. If not, add additional sealant to complete the cementing. Weigh both rods. If one rod is lighter than the other, add small amounts of sealant to both ends of the rod. Re-weigh. Add more sealant if necessary.

**Step 5.** Spread some sealant on the inside of the PVC caps. Slide them onto the ends of the tubes to cement them in place.

**Step 6.** Use fine sand paper to clean the rods.

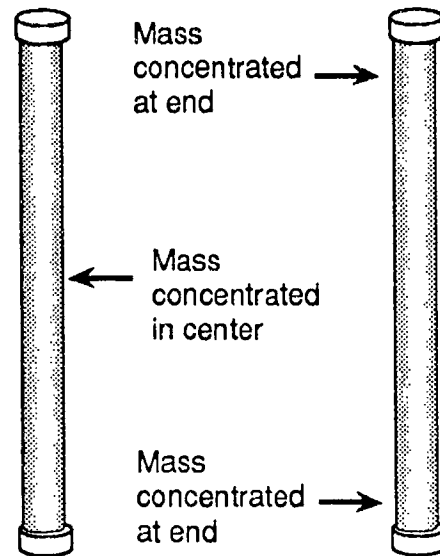
**QUESTIONS:**

1. How does the placement of mass in the two rods affect the ease with which they are rotated from side to side? Why?
2. If an equal side to side rotational force (known as torque) was exerted on the middle of each rod, which one would accelerate faster?

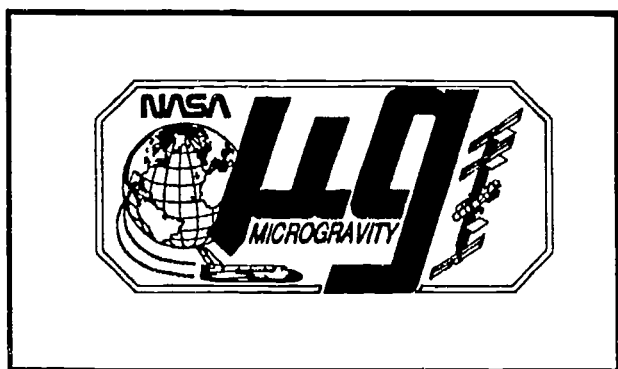

## Activity 6

# Gravity-Driven Fluid Flow

## OBJECTIVE:

To observe the gravity-driven fluid flow that is caused by differences in solution density

## BACKGROUND:

Many crystals grow in solutions of different compounds. For example, crystals of salt grow in concentrated solutions of salt dissolved in water. Crystals of proteins and other molecules grown in experiments on the Space Shuttle are also grown in similar types of solutions.

Gravity has been shown to cause the fluid around a growing crystal to flow upward. "Up" is defined here as being opposite the direction of gravity. This flow of fluid around the growing crystal is suspected to be detrimental to some types of crystal growth. Such flow may disrupt the arrangement of atoms or molecules on the surface of the growing crystal, making further growth non-uniform.

Understanding and controlling solution flows is vital to studies of crystal growth. The flow appears to be caused by differences in the density of solutions which, in the presence of gravity, create fluid motion around the growing crystal. The solution nearest the crystal surface deposits its chemical material onto the crystal surface, thereby reducing the molecular weight of the solution. The lighter solution tends to float upward, thus creating fluid motion. This experiment recreates the

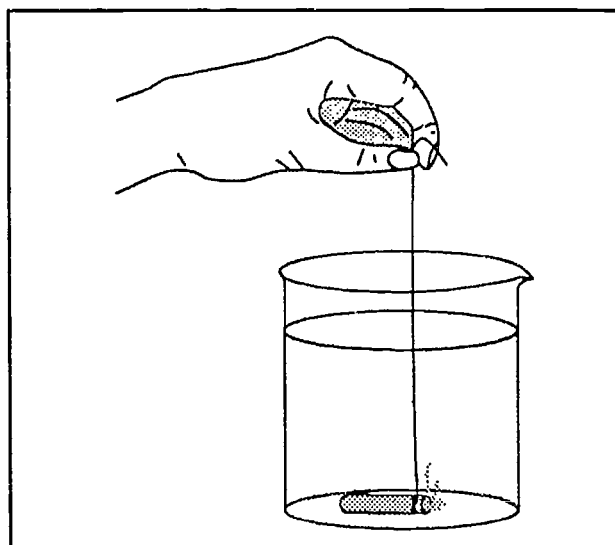

phenomenon of gravity-driven fluid motion and makes it visible.

## PROCEDURE:

- Step 1.** Fill the large glass container with very salty water.
- Step 2.** Fill the small vial with unsalted water and add two or three drops of food coloring to make it a dark color.
- Step 3.** Attach a thread to the upper end of the vial, and lower it carefully but quickly into the salt water in the large container. Let the vial sit on the bottom undisturbed.
- Step 4.** Observe the results.
- Step 5.** Repeat the experiment using colored salt water in the small vial and unsalted water in the large container.
- Step 6.** Observe the results.



**MATERIALS NEEDED:**

Large (500 ml) glass beaker or tall drinking glass  
Small (5 to 10 ml) glass vial  
Thread  
Food coloring  
Salt  
Spoon or stirring rod

**QUESTIONS:**

1. Based on your observations, which solution is denser (salt water or unsalted, dyed water)?
2. What do you think would happen if salt water were in both the small vial and the large container? What would happen if unsalted water were in both the small vial and the large container?
3. What results would you expect if the experiment had been performed in a microgravity environment?
4. How does this experiment simulate what happens to a crystal growing in solution?

**FOR FURTHER RESEARCH:**

1. Repeat the experiment, but replace the water in the small vial with hot, unsalted water. Replace the salt water in the large container with cold, unsalted water.
2. Repeat the experiment with different amounts of salt.
3. Try replacing the salt in the experiment with sugar and/or baking soda.
4. Attempt to control the observed flows by combining the effects of temperature and salinity in each container.
5. Try to observe the fluid flows without using food coloring. You will have to observe carefully to see the effects.

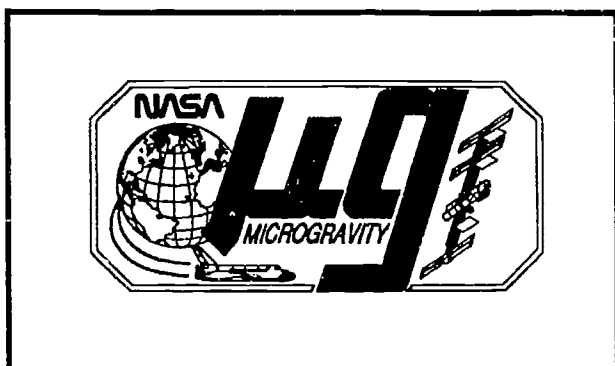

## Activity 7

# Candle Flames

## OBJECTIVE:

To illustrate the effects of gravity on the burning rate of candles

## BACKGROUND:

A candle flame is often used to illustrate the complicated physio-chemical processes of combustion. The flame surface itself represents the location where fuel vapor and oxygen mix at high temperature and with the release of heat. Heat from the flame melts the wax (typically a  $C_{20}$  to  $C_{35}$  hydrocarbon) at the base of the exposed wick. The liquid wax rises by capillary action up the wick, bringing it into closer proximity to the hot flame. This close proximity causes the liquid wax to vaporize. The wax vapors then migrate toward the flame surface, breaking down into smaller hydrocarbons enroute. Oxygen from the surrounding atmosphere also migrates toward the flame surface by diffusion and convection. The survival and location of the flame surface is determined by the balance of these processes.

In normal gravity, buoyancy-driven convection develops due to the hot, less dense combustion products. This action has several effects: (a) the hot reaction products are carried away due to their buoyancy, and fresh oxygen is carried toward the flame zone; (b) solid particles of soot form in the region between the flame and the wick and are convected upward,

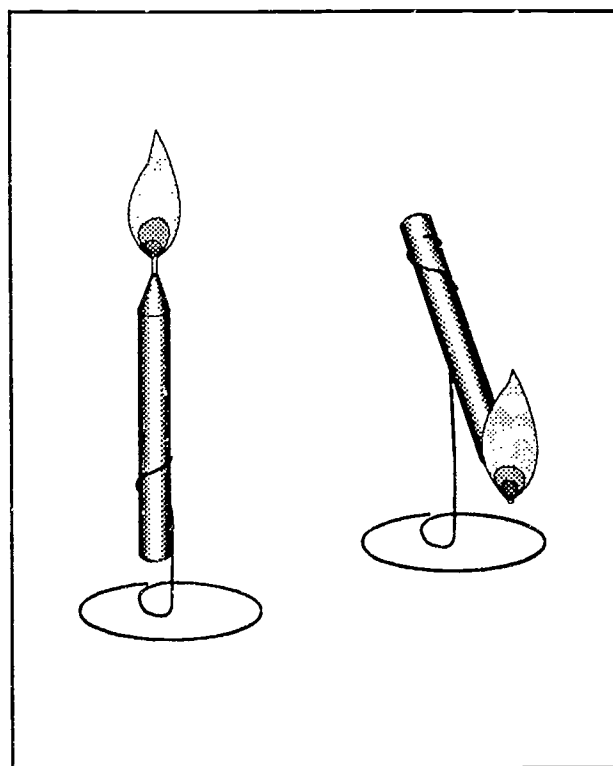

where they burn off, yielding the bright yellow tip of the flame; (c) to overcome the loss of heat due to buoyancy, the flame anchors itself close to the wick; (d) the combination of these effects causes the flame to be shaped like a tear drop.

In the absence of buoyancy-driven convection, as in microgravity, the supply of oxygen and fuel vapor to the flame is controlled by the much slower process of molecular diffusion. Where there is no "up" or "down," the flame tends toward sphericity. Heat lost to the top of the candle causes the base of the flame to be quenched, and only a portion of the sphere is seen. The diminished supply of oxygen and fuel causes the flame temperature to

be lowered to the point that little or no soot forms. It also causes the flame to anchor far from the wick, so that the burning rate (the amount of wax consumed per unit time) is reduced.

**MATERIALS NEEDED:**

Birthday candles (several)  
 Matches  
 Balance beam scale (0.1 gm or greater sensitivity)  
 Clock with second-hand or stopwatch  
 Wire cutter/pliers  
 Wire  
 Small pan to collect dripping wax

**PROCEDURE:**

- Step 1.** Form candle holders from the wire as shown in the diagram. Determine and record the weight of each candle and its holder.
- Step 2.** Light the "upright" candle and permit it to burn for one minute. As it burns, record the colors, size, and shape of the candle flame.
- Step 3.** Weigh the candle and holder and calculate how much mass was lost.
- Step 4.** Place the inverted candle on a small pan to collect dripping wax. (Note: The candle should be inverted to an angle of about 70 degrees from the horizontal. If the candle is too steep, dripping wax will extinguish the flame.)
- Step 5.** Light the candle and permit it to burn for one minute. As it burns, record the colors, size, and shape of the candle flame.
- Step 6.** Weigh the candle and holder and calculate how much mass was lost.

**QUESTIONS:**

1. Which candle burned faster? Why?
2. How were the colors and flame shapes and sizes different?
3. Why did one candle drip and the other not?
4. Which candle was easier to blow out?
5. What do you think would happen if you burned a candle horizontally?

**FOR FURTHER RESEARCH:**

1. Burn a horizontally-held candle. As it burns, record the colors, size, and shape of the candle flame. Weigh the candle and calculate how much mass was lost after one minute.
2. Repeat the above experiments with the candles inside a large jar. Let the candles burn to completion. Record the time it takes each candle to burn. Determine how and why the burning rate changes.
3. Burn two candles which are close together. Record the burning rate and weigh the candles. Is it faster or slower than each candle alone? Why?
4. Obtain a copy of Michael Faraday's book, The Chemical History of a Candle, and do the experiments described. (See reference list.)

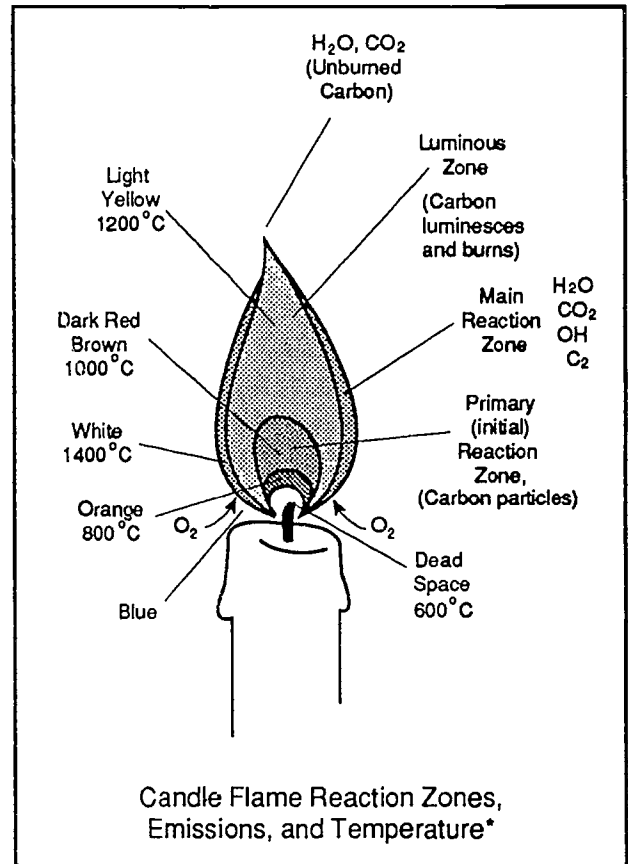
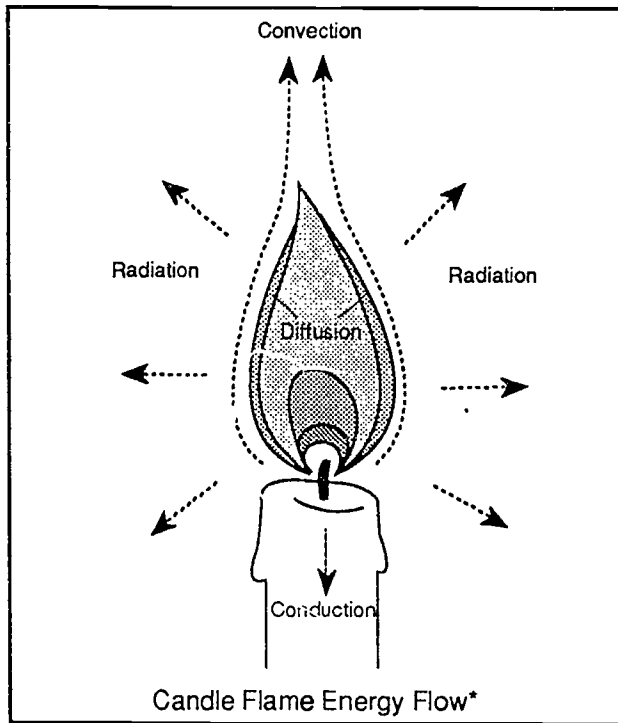

\*Candle flame diagrams adapted from "The Science of Flames poster," National Energy Foundation, Salt Lake City, UT.

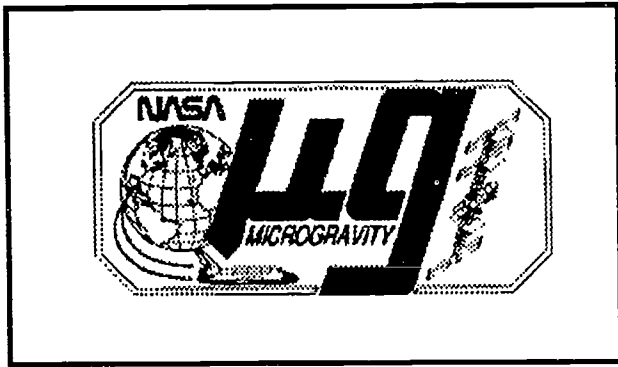

## Activity 8

# Candle Drop

## OBJECTIVE:

To observe candle flame properties in free fall

## BACKGROUND:

Drop tower and Space Shuttle experiments have provided scientists valuable insights on the dynamics and chemistry of combustion. In both research environments, a flammable material is ignited by a hot wire, and the combustion process is recorded by movie cameras and other data collection devices.

The sequence of pictures beginning at the bottom of this page illustrates a combustion experiment conducted at the NASA Lewis Research Center 150 Meter Drop Tower. These pictures of a candle flame were recorded during a 5-second drop tower test. An electrically-heated wire was used to ignite the candle and then withdrawn one second into the drop. As the

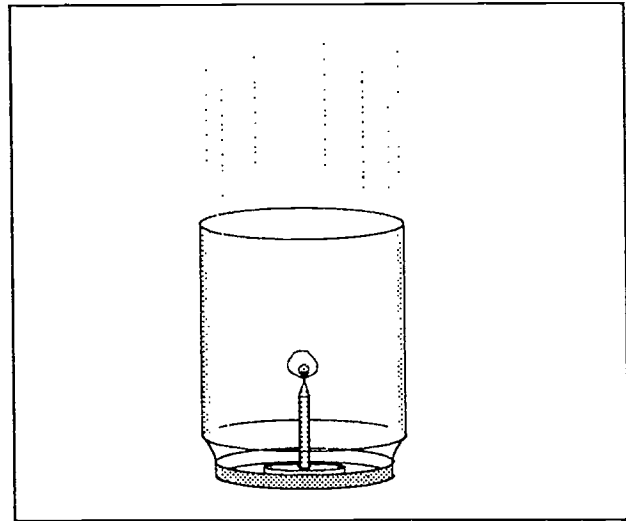

Combustion Drop Test  
NASA Lewis Research Center



Hot Wire Ignition in Microgravity

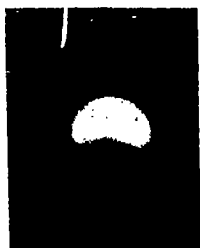

1 second



2 seconds



3 seconds



4 seconds



5 seconds

pictures illustrate, the flame stabilizes quickly, and its shape appears to be constant throughout the remainder of the drop.

Microgravity tests performed on the Space Shuttle furthered this research by determining the survivability of a candle flame. If the oxygen does not diffuse rapidly enough to the flame front, the flame temperature will diminish. Consequently, the heat feedback to and vaporization of the candle wax will be reduced. If the flame temperature and these other processes fall below critical values, the candle flame will be extinguished. Candles on board the first United States Microgravity Laboratory, launched in June 1992, burned from 45 seconds to longer than 60 seconds.

#### **MATERIALS NEEDED:**

Clear plastic jar and lid (2 liter volume)\*  
 Wood block  
 Screws  
 Birthday-size candles  
 Matches  
 Drill and bit  
 Video camera and monitor (optional)  
 \* Empty large plastic peanut butter jar can be used.

#### **PROCEDURE:**

- Step 1.** Cut a small wood block to fit inside the lid of the jar. Attach the block to the jar lid with screws from the top.
- Step 2.** Drill a hole in the center of the block to serve as a candle-holder.
- Step 3.** Insert a candle into the hole. Darken the room. With the lid on the bottom, light the candle and quickly screw the plastic jar over the candle.

**Step 4.** Observe the shape, brightness, and color of the candle flame. If the oxygen inside the jar is depleted before the observations are completed, remove the jar and flush out the foul air. Relight the candle and seal the jar again.

**Step 5.** Raise the jar towards the ceiling of the room. Drop the jar with the lit candle to the floor. Position a student near the floor to catch the jar.

**Step 6.** As the candle drops, observe the shape, brightness, and color of the candle flame. Because the action takes place very quickly, perform several drops to complete the observation process.

#### **QUESTIONS:**

1. Did the candle flame change shape during the drop? If so, what new form did the flame take and why?
2. Did the brightness of the candle flame change? If it did change, why?
3. Did the candle flame go out? If the flame did go out, when did it go out and why?
4. Were the observations consistent from drop to drop?

#### **FOR FURTHER RESEARCH:**

1. If videotape equipment is available, videotape the candle flame during the drop. Use the pause control during the playback to examine the flame shape.
2. If a balcony is available, drop the jar from a greater distance than is possible in a classroom. Does the candle continue to burn through the entire drop? For longer drops, it is recommended that a catch basin be used to catch the jar. Fill up a large box or a plastic trash can with styrofoam packing material or loosely crumpled newspaper.



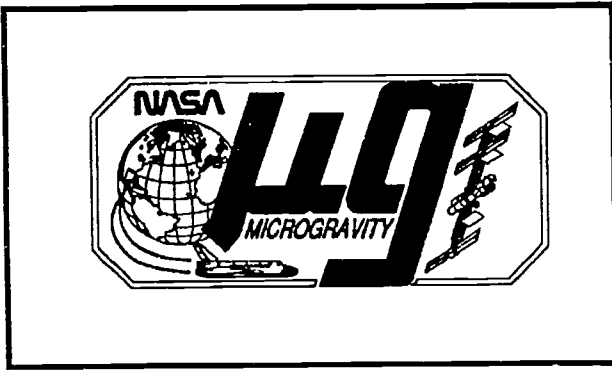

### OBJECTIVE:

To measure the contact angle of a fluid

### BACKGROUND:

In the absence of the stabilizing effect of gravity, fluids partly filling a container in space are acted on primarily by surface forces and can behave in striking, unfamiliar ways. Scientists must understand this behavior to manage fluids in space effectively.

Liquids always meet clean, smooth, solid surfaces in a definite angle, called the contact angle. This angle can be measured by observing the attraction of fluid into sharp corners by surface forces. Even in Earth's gravity, the measurement technique can be observed. If a corner is vertical and sharp enough, surface forces win out over the downward pull of gravity, and the fluid moves upward into the corner. If the angle between the two glass planes is slowly decreased, the fluid the glass is standing in jumps up suddenly when the critical value of the corner angle is reached. In the absence of gravity's effects, the jump would be very striking, with a large amount of fluid pulled into the corner.

### Activity 9

## Contact Angle

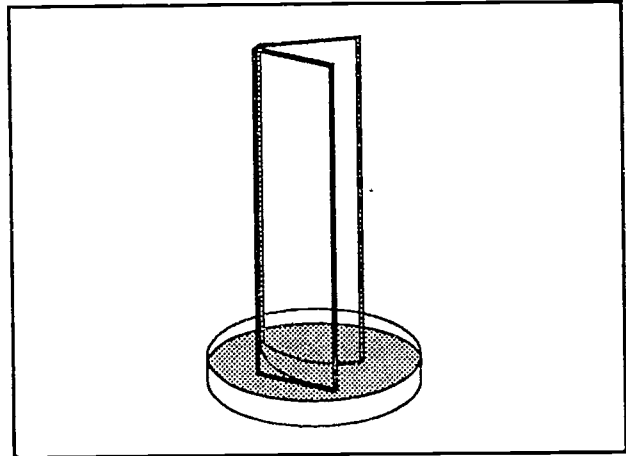

### PROCEDURE:

- Step 1.** Place a small amount of distilled water in a dish. (Note: It is important that the dish and the slides are clean.)
- Step 2.** Place two clean microscope slides into the water so that their ends touch the bottom of the dish and the long slides touch each other at an angle of at least 30 degrees. (Optional step: You may find it easier to manipulate the slides if a tape hinge is used to hold the slides together.)
- Step 3.** Slowly close the angle between the two slides.
- Step 4.** Stop closing the angle when the water rises between the slides. Use the protractor to measure the contact angle (angle the water rises up between the slides). Also measure the angle between the two slides.

**MATERIALS NEEDED:**

Distilled water  
 Microscope slides  
 Shallow dish  
 Protractor  
 Cellophane tape

**FOR FURTHER RESEARCH:**

1. Add some food coloring to the water to make it easier to see. Does the addition of coloring change the contact angle?
2. Measure the contact angle for other liquids. Add a drop of liquid soap or alcohol to the water to see if it alters water's contact angle.
3. Try opening the wedge of the two slides after the water has risen. Does the water come back down easily to its original position?

**QUESTIONS:**

1. What is the mathematical relationship between the contact angle and the angle between the two slides?

$$\text{Contact angle} = 90 - 1/2 \text{ wedge angle}$$

2. Why is it important to understand the behavior of fluids in microgravity?

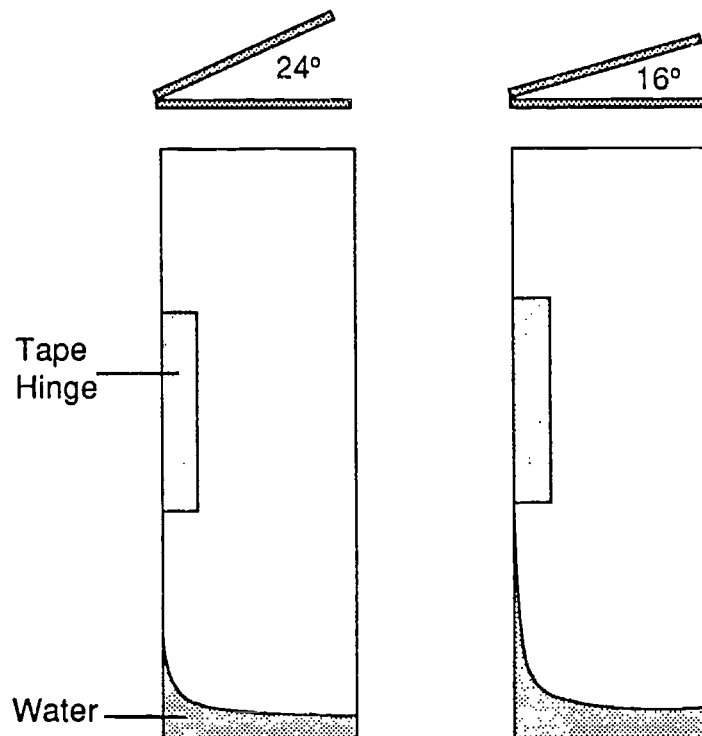

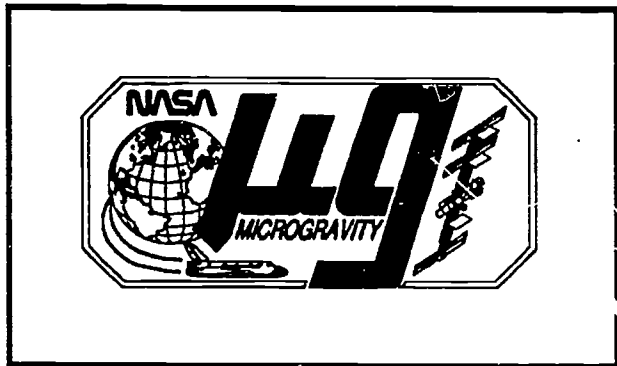

## OBJECTIVE:

To illustrate the effects of gravity and surface tension on fiber pulling

## BACKGROUND:

Fiber pulling is an important process in the manufacture of synthetic fabrics such as nylon and polyester and more recently, in the manufacture of optical fibers for communication networks. Chances are, when you use the telephone for long distance calls, your voice is carried by light waves over optical fibers.

Fibers can be drawn successfully only when the fluid is sufficiently viscous or "sticky." Two effects limit the process: gravity tends to cause the fiber to stretch and break under its own weight, and surface tension causes the fluid to have as little surface area as possible for a given volume. A long slender column of liquid responds to this latter effect by breaking up into a series of small droplets. A sphere has less surface area than a cylinder of the same volume. This effect is known as the "Rayleigh instability" after the work of Lord Rayleigh who explained this behavior mathematically in the late 1800's. A high viscosity slows the fluid motion and allows the fiber to stiffen as it cools before these effects cause the strand to break apart.

Some of the new exotic glass systems under consideration for improved optical fibers are much less viscous in the melt than the quartz used to make the fibers presently

## Activity 10

# Fiber Pulling

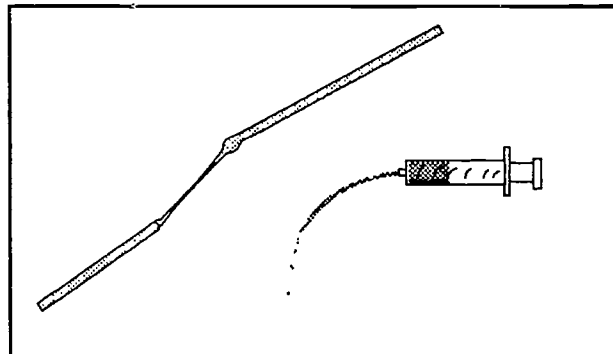

in use: this low viscosity makes them difficult to draw into fibers. The destructive effects of gravity could be reduced by forming fibers in space. However, the Rayleigh instability is still a factor in microgravity. Can a reduction in gravity's effects extend the range of viscosities over which fibers can be successfully drawn? This question must be answered before we invest heavily in developing expensive experiment apparatus to test high temperature melts in microgravity. Fortunately, there are a number of liquids that, at room temperature, have fluid properties similar to those of molten glass. This allows us to use common fluids to model the behavior of molten materials in microgravity.

## PROCEDURE: (for several demonstrations)

**Step 1.** While wearing eye and hand protection, use the propane torch or Bunsen burner to melt a blob of glass at one end of a stirring rod. Touch a second rod to the melted blob and pull a thin strand downward. Measure how long the fiber gets before it breaks. **Caution: When broken, the fiber fragments are sharp. Dispose of safely.**

**MATERIALS NEEDED:**

Propane torch or Bunsen burner  
 Small-diameter glass stirring rods (soft glass)  
 Disposable syringes (10 ml) without needles  
 Various fluids (water, honey, corn syrup,  
 mineral oil, and light cooking oil)  
 Small ball bearings or BBs  
 Small graduated cylinders or test tubes (at  
 least 5 times the diameter of the ball  
 bearing)  
 Stopwatch or clock with second-hand  
 Eye protection  
 Protective gloves  
 Metric ruler

- Step 2.** Squirt a small stream of water from the syringe. Observe how the stream breaks up into small droplets after a short distance. This breakup is caused by the Rayleigh instability of the liquid stream. Measure the length of the stream to the point where the break-up occurs. Do the same for other liquids and compare the results.
- Step 3.** Touch the end of a cold stirring rod to the surface of a small quantity of water. Try to draw a fiber.
- Step 4.** Repeat #3 with more viscous fluids, such as honey.
- Step 5.** Compare the ability to pull strands of the various fluids with the molten glass and with the measurements made in step 2.
- Step 6.** Pour about 5 centimeters of water into a small test tube. Drop the ball bearing into the tube. Record the time it takes for the ball bearing to reach the bottom. (This is a measure of the viscosity of the fluid.)
- Step 7.** Repeat #6 for each of the fluids. Record the fall times through each fluid.

**QUESTIONS:**

- Which of the fluids has the closest behavior to molten glass? Which fluid has the least similar behavior to molten glass? (Rank the fluids.)
- How do the different fluids compare in viscosity (ball bearing fall times)? What property of the fluid is the most important for modeling the behavior of the glass melt?
- What is the relationship between fiber length and viscosity of the fluid?

**FOR FURTHER RESEARCH:**

- With a syringe, squirt a thin continuous stream of each of the test fluids downward into a pan or bucket. Carefully observe the behavior of the stream as it falls. Does it break up? How does it break up? Can you distinguish whether the breakup is due to gravity effects or to the Rayleigh instability? How does the strand break when the syringe runs out of fluid? (For more viscous fluids, it may be necessary to do this experiment in the stairwell with students stationed at different levels to observe the breakup.)
- Have the students calculate the curved surface area (ignore the area of the end caps) of cylinders with length to diameter ratios of 1, 2, 3, and 4 of equal volume. Now, calculate the surface area of a sphere with the same volume. Since nature wants to minimize the surface area of a given volume of free liquid, what can you conclude by comparing these various ratios of surface area to volume ratios? (Note: This calculation is only an approximation of what actually happens. The cylinder (without the end caps) will have less surface area than a sphere of the same volume until its length exceeds 2.25 times its diameter from the above calculation. Rayleigh's theory calculates the increase in surface area resulting from a disturbance in the form of a periodic surface wave. He showed that for a fixed volume, the surface area would increase if the wavelength was less than  $\pi$  times the diameter, but would decrease for longer waves. Therefore, a long slender column of liquid will become unstable and will break into droplets separated by  $\pi$  times the diameter of the column.)

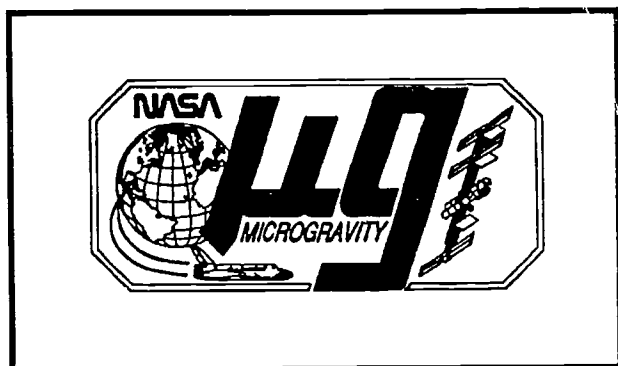

### OBJECTIVE:

To observe crystal growth phenomena in a 1-g environment

### BACKGROUND:

A number of crystals having practical applications, such as L-arginine phosphate (LAP) and triglycine sulfate (TGS), may be grown from solutions. In a one-gravity environment, buoyancy-driven convection may be responsible for the formation of liquid inclusions and other defects which can degrade the performance of devices made from these materials. The virtual absence of convection in a microgravity environment may result in far fewer inclusions than in crystals grown on Earth. For this reason, solution crystal growth is an active area of microgravity research.

Crystal growing experiments consist of a controlled growth environment on Earth and an experimental growth environment in microgravity on a spacecraft. In this activity, students will become familiar with crystal growing in 1-g. One or more crystals of alum (aluminum potassium sulfate or  $\text{AlK}(\text{SO}_4)_2 \cdot 12\text{H}_2\text{O}$ ) will be grown from seed crystals suspended in a crystal growth solution. With the use of collimated light, shadowgraph views of the growing crystals will reveal buoyancy-driven convective plumes in the growth solution. (Refer to activity 6 for additional background information.)

### Activity 11

# Crystal Growth

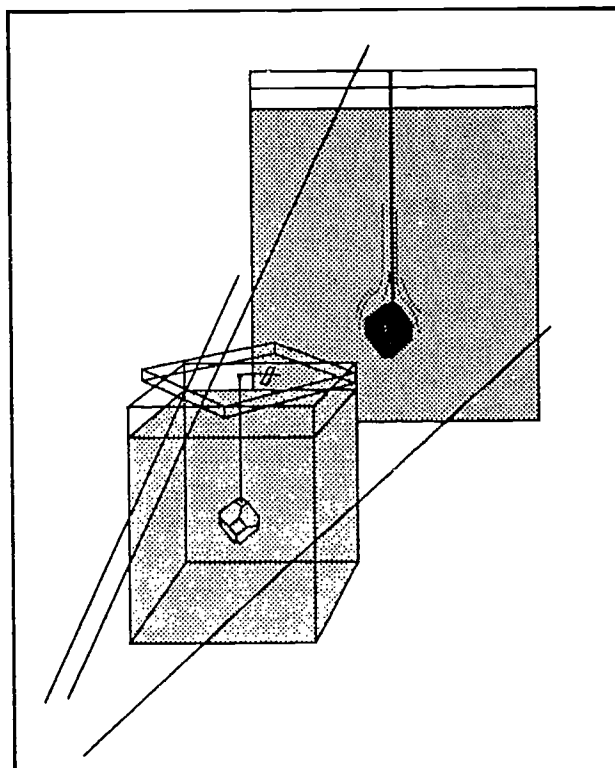

### PROCEDURE:

- Step 1.** Create a seed crystal of alum by dissolving some alum in a small quantity of water in a beaker. Permit the water to evaporate over several days. Small crystals will form along the sides and bottom of the beaker.
- Step 2.** Remove one of the small crystals of alum and attach it to a short length of monofilament fishing line with a dab of silicone cement.
- Step 3.** Prepare the crystal growth solution by dissolving powdered or crystal-line alum in a beaker of warm

**MATERIALS NEEDED:**

Aluminum Potassium Sulfate

 $\text{AlK}(\text{SO}_4)_2 \cdot 12\text{H}_2\text{O}^*$ 

Square acrylic box\*\*

Distilled water

Stirring rod

Monofilament fishing line

Silicone cement

Beaker

Slide projector

Projection screen

Eye protection

Hot plate

Thermometer

Balance

\*Refer to the chart on the next page for the amount of alum needed for the capacity of the growth chamber (bottle) you use.

\*\*Clear acrylic boxes, about 10x10x13 cm are available from craft stores. Select a box that has no optical distortions.

water. The amount of alum that can be dissolved in the water depends upon the amount of the water used and its temperature. Refer to the table (Alum Solubility in Water) for the quantity required.

- Step 4.** When no more alum can be dissolved in the water, transfer the solution to the growth chamber acrylic box.
- Step 5.** Punch a small hole through the center of the lid of the box. Thread the seed crystal line through the hole and secure it in place with a small amount of tape. Place the seed crystal in the box and place the lid on the box at a 45 degree angle. This will expose the surface of the solution to the outside air to promote evaporation. It may be necessary to adjust the length of

the line so that the seed crystal is several centimeters above the bottom of the bottle.

- Step 6.** Set the box aside in a place where it can be observed for several days without being disturbed. If the crystal should disappear, dissolve more alum into the solution and suspend a new seed crystal.
- Step 7.** Record the growth rate of the crystal by comparing it to a metric ruler. The crystal may also be removed and its mass measured on a balance.
- Step 8.** Periodically observe the fluid flow associated with the crystal's growth by directing the light beam of a slide projector through the box to a projection screen. Observe plumes around the shadow of the crystal. Convection currents in the growth solution distort the light passing through the growth solution.

**QUESTIONS:**

1. What is the geometric shape of the alum crystal?
2. What can cause more than one crystal to form around a seed?
3. What do shadowgraph plumes around the growing crystal indicate? Do you think that plumes would form around crystals growing in microgravity?
4. Does the growth rate of the crystal remain constant? Why or why not?
5. What would cause a seed crystal to disappear? Could a crystal decrease in size? Why?
6. What are some of the possible applications for space-grown crystals?



**FOR FURTHER RESEARCH:**

1. Grow additional alum crystals without the cap placed over the box. In one experiment, permit the growth solution to evaporate at room temperature. In another, place the growth chamber in a warm area or even on a hot plate set at the lowest possible setting. Are there any differences in the crystals produced compared to the first one grown? How does the growth rate compare in each of the experiments?
2. Experiment with growing crystals of other chemicals such as table salt, copper sulfate, chrome alum, Rochelle salt, etc. Caution: Become familiar with potential hazards of any of the chemicals you choose and take appropriate safety precautions.
3. Review scientific literature for results from microgravity crystal growing experiments.

**Alum Solubility in Water**  
 $\text{AlK}(\text{SO}_4)_2 \cdot 12\text{H}_2\text{O}$

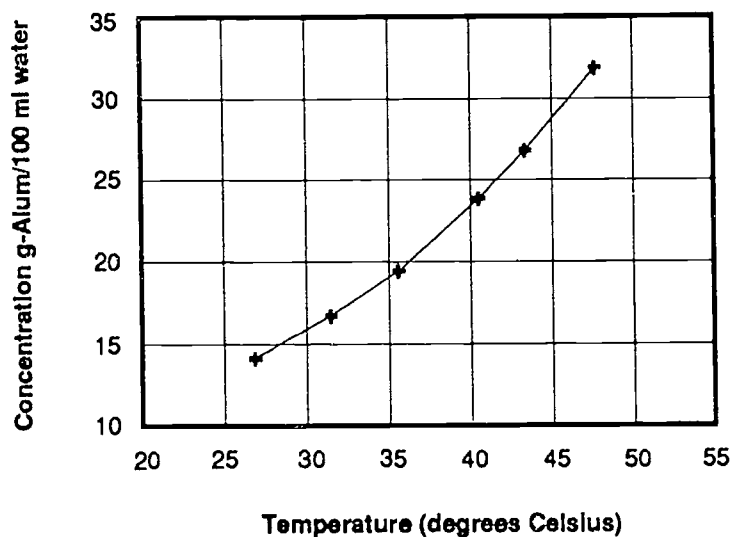

Shadowgraph image of a growth plume rising from a growing crystal.

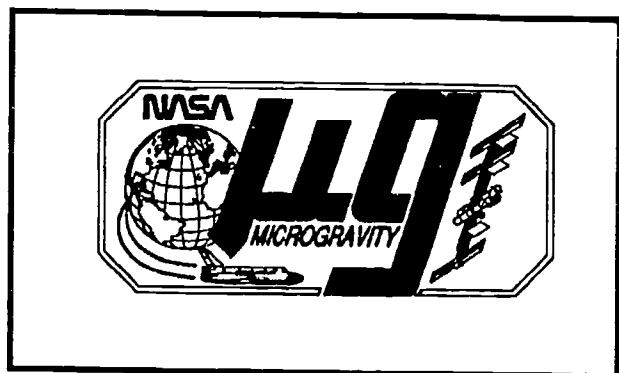

## Activity 12

# Microscopic Observation of Crystal Growth

## OBJECTIVE:

To observe crystal nucleation and growth rate during directional solidification

## BACKGROUND:

Directional solidification refers to a process by which a liquid is transformed (by freezing) into a solid through the application of a temperature gradient in which heat is removed from one direction. A container of liquid will turn to a solid in the direction the temperature is lowered. If this liquid has a solute present, typically, some of the solute will be rejected into the liquid ahead of the liquid/solid interface. However, this rejection does not always occur, and in some cases, the solute is incorporated into the solid. This phenomenon has many important consequences for the solid. As a result, solute rejection is studied extensively in solidification experiments.

The rejected material tends to build up at the interface to form a mass boundary layer. This experiment demonstrates what happens when the growth rate is too fast and solute in the boundary layer is trapped.

Fluid flow in the melt can also affect the buildup of the mass boundary layer. On Earth, fluids that expand become less dense. This causes a vertical flow of liquid which will interfere with the mass boundary layer. In space, by avoiding this fluid flow, a more uniform mass boundary layer will be

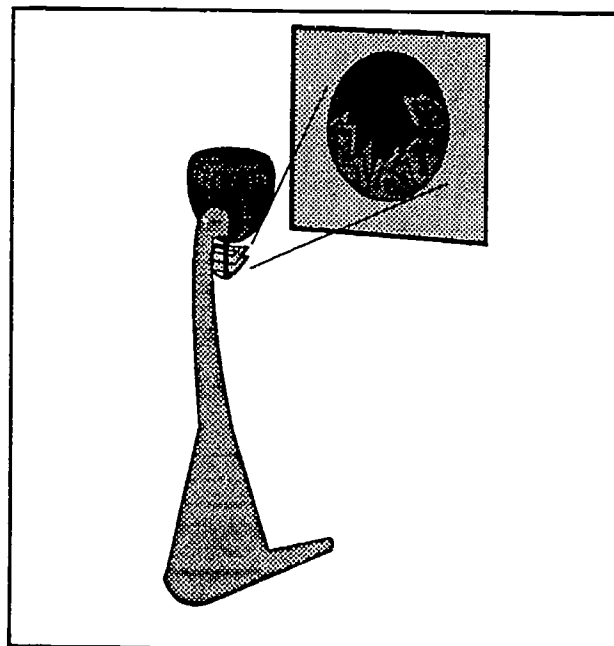

achieved. This, in turn, will improve the uniformity with which the solute is incorporated into the growing crystal.

## PROCEDURE:

### Observations of Mannite\*

**Step 1.** Place a small amount of mannite on a microscope slide and place the slide on a hot plate. Raise the temperature of the hot plate until the mannite melts. Be careful not to touch the hotplate or heated slide. Handle the slide with forceps.

**MATERIALS NEEDED:**

Bismarck Brown Y\*\*  
 Mannite (d-Mannitol)  
 $\text{HOCH}_2(\text{CHOH})_4\text{CH}_2\text{OH}^*$   
 Salol (Phenyl Salicylate)  
 $\text{C}_{13}\text{H}_{10}\text{O}_3^{**}$   
 Microprojector  
 Student microscopes (alternate to  
 microprojector)  
 Glass microscope slides with cover  
 glass  
 Ceramic bread and butter plate  
 Refrigerator  
 Hot plate  
 Desktop coffee cup warmer  
 Forceps  
 Dissecting needle  
 Spatula  
 Eye protection  
 Gloves  
 Marker pen for writing on slides

**Step 2.** After melting, cover the mannite with a cover glass and place the slide on a ceramic bread-and-butter plate that has been chilled in a refrigerator. Permit the liquid mannite to crystallize.

**Step 3.** Observe the sample with a microprojector. Note the size, shape, number, and boundaries of the crystals.

**Step 4.** Prepare a second slide, but place it immediately on the microprojector stage. Permit the mannite to cool slowly. Again, observe the size, shape, and boundaries of the crystals. Mark and save the two slides for comparison using student microscopes. Forty power is sufficient for comparison. Have the students make sketches of the crystals on the two slides and label them by cooling rate.

**Observations of Salol**

**Step 5.** Repeat the procedure for mannite (steps 1-4) with the salol, but do not use glass cover slips. Use a desktop coffee cup warmer to melt the salol. It may be necessary to add a seed crystal to the liquid on each slide to start the crystallization. Use a spatula to carry the seed to the salol. If the seed melts, wait a moment and try again when the liquid is a bit cooler. (If the microprojector you use does not have heat filters, the heat from the lamp may remelt the salol before crystallization is completed. The chemical thymol ( $\text{C}_{10}\text{H}_{14}\text{O}$ ) may be substituted for the salol. Avoid breathing its vapors. Do not substitute thymol for salol if student microscopes are used.)

**Step 6.** Prepare a new salol slide and place it on the microprojector stage. Drop a tiny seed crystal into the melt and observe the solid-liquid interface.

**Step 7.** Remelt the salol on the slide and sprinkle a tiny amount of Bismarck Brown on the melt. Drop a seed crystal into the melt and observe the motion of the Bismarck Brown granules. The granules will make the movements of the liquid visible. Pay close attention to the granules near the growing edges and points of the salol crystals. How is the liquid moving?

**NOTES ON CHEMICALS USED:****Bismarck Brown Y**

Bismarck Brown is a stain used to dye bone specimens for microscope slides. Because Bismarck Brown is a stain, avoid getting it on your fingers. Bismarck Brown is water soluble.

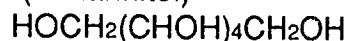
**Mannite (d-Mannitol)**

Mannite has a melting point of approximately 168° C. It may be harmful if inhaled or swallowed.

Wear eye protection and gloves when handling this chemical. Conduct the experiment in a well ventilated area.

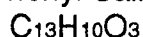
**Salol (Phenyl Salicylate)**

It has a melting point of 43° C. It may irritate eyes. Wear eye protection.

**QUESTIONS:**

1. What happens to crystals when they begin growing from multiple nuclei?
  2. Are there any differences in crystals that form from a melt that has cooled rapidly and from one that has cooled slowly? What are those differences?
  3. What happens to the resulting crystals when impurities exist in the melt?
4. What caused the circulation patterns of the liquid around the growing crystal faces? Do you think these circulation patterns affect the atomic arrangements of the crystals?
  5. How do you think the growth of the crystals would be affected by growing them in microgravity?

**FOR FURTHER RESEARCH:**

1. Design a crystal growing experiment that could be flown in space. The experiment should be self-contained and the only astronaut involvement that of turning on and off a switch.
2. Design a crystal growing experiment for space flight that requires astronaut observations and interpretations.
3. Research previous crystal growing experiments in space and some of the potential benefits researchers expect from space-grown crystals.

- \* Because of the higher temperatures involved, the mannite slides should be prepared by the teacher. If you wish, you may process the mannite slides at home in an oven. By doing so, you will eliminate the need for a hotplate. Mark the two prepared slides by cooling rate.
- \*\* Obtain the smallest quantities available from chemical supply houses.

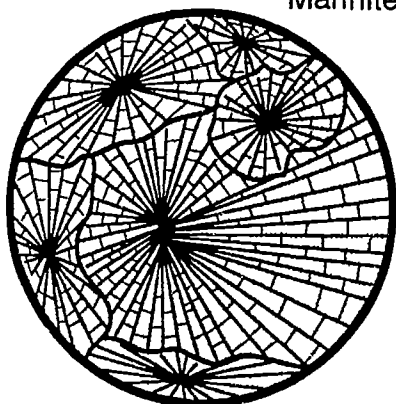
**Sample Microscope Sketches****Mannite Crystallization**

Slow Cooling



Fast Cooling

## Glossary

**Acceleration** - The rate at which an object's velocity changes with time.

**Buoyancy-Driven Convection** - Convection created by the difference in density between two or more fluids in a gravitational field.

**Convection** - Energy and/or mass transfer in a fluid by means of bulk motion of the fluid.

**Diffusion** - Intermixing of atoms and/or molecules in solids, liquids, and gases due to a difference in composition.

**Drop Tower** - Research facility that creates a microgravity environment by permitting experiments to free fall through an enclosed vertical tube.

**Exothermic** - Releasing heat.

**Fluid** - Anything that flows (liquid or gas).

**Free Fall** - Falling in a gravitational field where the acceleration is the same as that due to gravity alone.

**G** - Universal Gravitational Constant  
( $6.67 \times 10^{-11} \text{ Nm}^2/\text{kg}^2$ )

**g** - The acceleration Earth's gravitational field exerts on objects at Earth's surface.  
(approximately 9.8 meters per second squared)

**Gravitation** - The attraction of objects due to their masses.

**Inertia** - A property of matter that causes it to resist changes in velocity.

**Law of Universal Gravitation** - A law stating that every mass in the universe attracts every other mass with a force proportional to the product of their masses and inversely proportional to the square of the distances between their centers.

**Microgravity ( $\mu\text{g}$ )** - An environment that imparts to an object a net acceleration that is small compared with that produced by Earth at its surface.

**Parabolic Flight Path** - The flight path followed by airplanes in creating a microgravity environment (the shape of a parabola).

**Skylab** - NASA's first orbital laboratory that was operated in 1973 and 1974.

**Space Station Freedom** - NASA's international space station planned for operation by the end of the 1990's.

**Spacelab** - A scientific laboratory developed by the European Space Agency that is carried into Earth orbit in the Space Shuttle's payload bay.

## Microgravity References

- , (1981), Combustion Experiments in a Zero-gravity Laboratory, American Institute of Aeronautics and Astronautics, New York.
- , (1988), "Mastering Microgravity," *Space World*, v7n295, p4.
- , (1989), Chemistry: "Making Bigger, Better Crystals," *Science News*, v136n22, p349.
- , (1989), "Making Plastics in Galileo's Shadow," *Science News*, v136n18, p286.
- , (1992), "Can You Carry Your Coffee Into Orbit?," USRA Quarterly, Winter-Spring 1992.
- Chandler, D., (1991), "Weightlessness and Microgravity," *Physics Teacher*, v29n5, pp312-313.
- Cornia, R., (1991), "The Science of Flames," *The Science Teacher*, v58n8, pp43-45.
- Faraday, M., (1988), The Chemical History of a Candle, Chicago Review Press.
- Frazer, L., (1991), "Can People Survive in Space?," *Ad Astra*, v3n8, pp14-18.
- Froehlich, W., (1982), Spacelab, EP-165, National Aeronautics and Space Administration, Washington.
- Halliday, D. & Resnick, R., (1988), Fundamentals of Physics, John Wiley & Sons, New York.
- Howard, B., (1991), "The Light Stuff," *Omni*, v14n2, pp50-54.
- Lyons, J., (1985), Fire, Scientific American Publishers, Inc., Chapter 2.
- NASA, (1976 - ), Spinoff, National Aeronautics and Space Administration, Washington (annual publication).
- NASA, (1988), Science in Orbit — The Shuttle and Spacelab Experience: 1981-1986, NASA Marshall Space Flight Center, Huntsville, AL.
- Naumann, R. & Herring, H., (1980), Materials Processing In Space: Early Experiments, Scientific and Technical Information Branch, National Aeronautics and Space Administration, Washington.
- Noland, D., (1990), "Zero-G Blues," *Discover*, v11n5, pp74-80.
- NASA, (1991), "International Microgravity Laboratory-1, MW 010/12-91," Flight Crew Operations Directorate, NASA Johnson Space Center, Houston, TX.
- NASA, (1992), "Mission Highlights STS-42," MHL 010/2-92, Flight Crew Operations Directorate, NASA Johnson Space Center, Houston, TX.
- NASA, (1991), "United States Microgravity Laboratory-1, MW 013/6-92," Flight Crew Operations Directorate, NASA Johnson Space Center, Houston, TX.
- NASA, (1992), "Mission Highlights STS-50," MHL 013/7-92, Flight Crew Operations Directorate, NASA Johnson Space Center, Houston, TX.
- Pool, R., (1989), "Zero Gravity Produces Weighty Improvements," *Science*, v246n4930, p580.



## NASA Educational Resources

### NASA Spacelink: An Electronic Information System

NASA Spacelink is a computer information service that individuals may access to receive news about current NASA programs, activities, and other space-related information, historical data, current news, lesson plans, classroom activities, and even entire publications. Although it is primarily intended as a resource for teachers, the network is available to anyone with a personal computer and a modem.

Users need a computer, modem, communications software, and a long-distance telephone line to access Spacelink. The Spacelink computer access number is (205) 895-0028. The data word format is 8 bits, no parity, and 1 stop bit. For more information, contact:

Spacelink Administrator  
NASA Marshall Space Flight Center  
Mail Code CA21  
Marshall Space Flight Center, AL 35812  
Phone: (205) 544-0038

NASA Spacelink is also available through the Internet, a worldwide computer network connecting a large number of educational institutions and research facilities. Users with Internet access may reach NASA Spacelink at any of the following addresses:

spacelink.msfc.nasa.gov  
xsl.msfc.nasa.gov  
128.158.13.250

### NASA Educational Satellite Videoconferences

During the school year, NASA delivers a series of educational programs by satellite to teachers across the country. The content of each videoconference varies, but all cover aeronautics or space science topics of interest to the educational community. The broadcasts are interactive: a number is flashed across the bottom of the screen, and viewers may call collect to ask questions or to take part in the discussion. For further information, contact:

Videoconference Coordinator  
NASA Aerospace Education Services Program  
300 North Cordell  
Oklahoma State University  
Stillwater, OK 74078-0422  
Phone: (405) 744-7015

Dr. Malcom V. Phelps  
Technology and Evaluation Branch  
Education Division  
Code FET  
NASA Headquarters  
Washington, DC 20546  
Phone: (202) 358-1540

## Teacher Resource Center Network

To make additional information available to the education community, NASA's Education Division has created the NASA Teacher Resource Center Network. Teacher Resource Centers (TRCs) contain a wealth of information for educators: publications, reference books, slides, audio cassettes, videocassettes, telelecture programs, computer programs, lesson plans and activities, and lists of publications available from government and nongovernment sources. Because each NASA Field Center has its own areas of expertise, no two TRCs are exactly alike. Phone calls are welcome if you are unable to visit the TRC that serves your geographic area. A list of Centers and the geographic regions they serve starts at the bottom of this page.

To offer more educators access to NASA educational materials, NASA has formed partnerships with universities, museums, and other educational institutions to serve as Regional Teacher Resource Centers (RTRCs). For the location of the RTRC nearest you, please contact the TRC serving your geographic region.

**NASA's Central Operation of Resources for Educators (CORE)** was established as part of the Teacher Resource Center Network to facilitate the national and international distribution of NASA-produced educational materials in audiovisual format. Orders are processed for a small fee that includes the cost of the media. Send a written request on your school letterhead for a catalogue and order forms. For more information, contact:

**NASA CORE**  
Lorain County Joint Vocational School  
15181 Route 58 South  
Oberlin, OH 44074  
Phone: (216) 774-1051, Ext. 293 or 294

## National Aeronautics and Space Administration General Information for Teachers and Students

### IF YOU LIVE IN:

### Center Education Program Officer

### Teacher Resource Center

Alaska	Nevada	Mr. Garth A. Hull	NASA Teacher Resource Center
Arizona	Oregon	Chief, Educational Programs Branch	Mail Stop TO-25
California	Utah	Mail Stop TO-25	<b>NASA Ames Research Center</b>
Hawaii	Washington	<b>NASA Ames Research Center</b>	Moffett Field, CA 94035
Idaho	Wyoming	Moffett Field, CA 94035	PHONE: (415) 604-3574
Montana		PHONE: (415) 604-5543	
Connecticut	New Hampshire	Mr. Elva Bailey	NASA Teacher Resource Laboratory
Delaware	New Jersey	Chief, Educational Programs	Mail Code 130.3
District of Columbia	New York	Public Affairs Office (130)	<b>NASA Goddard Space Flight Center</b>
Maine	Pennsylvania	<b>NASA Goddard Space Flight Center</b>	Greenbelt, MD 20771
Maryland	Rhode Island	Greenbelt, MD 20771	PHONE: (301) 286-8570
Massachusetts	Vermont	PHONE: (301) 286-7207	
Colorado	North Dakota	Dr. Robert W. Fizmaurice	NASA Teacher Resource Room
Kansas	Oklahoma	Center Education Program Officer	Mail Code AP-4
Nebraska	South Dakota	Public Affairs Office (AP-4)	<b>NASA Johnson Space Center</b>
New Mexico	Texas	<b>NASA Johnson Space Center</b>	Houston, TX 77058
		Houston, TX 77058	PHONE: (713) 483-8696
		PHONE: (713) 483-1257	

**IF YOU LIVE IN:**

Florida  
Georgia  
Puerto Rico  
Virgin Islands

**Center Education Program Officer**

Mr. Raymond R. Corey  
Chief, Education and Awareness Branch  
Mail Code PA-EAB  
**NASA Kennedy Space Center**  
Kennedy Space Center, FL 32899  
PHONE: (407) 867-4444

**Teacher Resource Center**

**NASA Educators Resource Laboratory**  
Mail Code ERL  
**NASA Kennedy Space Center**  
Kennedy Space Center, FL 32899  
PHONE: (407) 867-4090

Kentucky  
North Carolina  
South Carolina  
Virginia  
West Virginia

Dr. Karen R. Credeur  
Head, Office of Public Services  
Mail Stop 154  
**NASA Langley Research Center**  
Hampton, VA 23665-5225  
PHONE: (804) 864-3307

**NASA Teacher Resource Center**  
Mail Stop 146  
**NASA Langley Research Center**  
Hampton, VA 23665-5225  
PHONE: (804) 864-3293

Illinois  
Indiana  
Michigan

Minnesota  
Ohio  
Wisconsin

Dr. Lynn Bondurant  
Chief, Office of Educational Programs  
Mail Stop 7-4  
**NASA Lewis Research Center**  
21000 Brookpark Road  
Cleveland, OH 44135  
PHONE: (216) 433-5583

**NASA Teacher Resource Center**  
Mail Stop 8-1  
**NASA Lewis Research Center**  
21000 Brookpark Road  
Cleveland, OH 44135  
PHONE: (216) 433-2017

Alabama  
Arkansas  
Iowa

Louisiana  
Missouri  
Tennessee

Mr. William E. Anderson  
Chief, Education Services Branch  
Public Affairs Office (CA 21)  
**NASA Marshall Space Flight Center**  
Marshall Space Flight Center, AL 35812  
PHONE: (205) 544-7391

**NASA Teacher Resource Center**  
**U.S. Space and Rocket Center**  
Huntsville, AL 35807  
PHONE: (205) 544-5812

Mississippi

Mr. Marco Giardino  
Center Education Program Officer  
Mail Stop AA00  
**NASA John C. Stennis Space Center**  
Stennis Space Center, MS 39529  
PHONE: (601) 688-2739

**NASA Teacher Resource Center**  
Building 1200  
**NASA John C. Stennis Space Center**  
Stennis Space Center, MS 39529  
PHONE: (601) 688-3338

The Jet Propulsion Laboratory (JPL) serves inquiries from all over the nation related to space and planetary exploration and other JPL activities.

Mr. Richard Alvidrez  
Manager, Public Education Office  
Mail Code 180-205  
**Jet Propulsion Laboratory**  
4800 Oak Grove Drive  
Pasadena, CA 91109  
PHONE: (818) 354-8592

**NASA Teacher Resource Center**  
JPL Educational Outreach  
Mail Stop CS-530  
**Jet Propulsion Laboratory**  
4800 Oak Grove Drive  
Pasadena, CA 91109  
PHONE: (818) 354-6916

\* U.S. G.P.O.: 1992-329-095



National Aeronautics and  
Space Administration

Washington, DC 20546-0001

Official Business  
Penalty for Private Use, \$300



NO POSTAGE  
NECESSARY  
IF MAILED  
IN THE  
UNITED STATES



**BUSINESS REPLY MAIL**  
First Class Permit No. 12028 Washington DC

POSTAGE WILL BE PAID BY NASA

Education Division  
NASA Headquarters  
Code FET  
Washington, DC 20277-2028

62





Educators and scientists at the National Aeronautics and Space Administration would appreciate your taking a few minutes to respond to the statements and questions below. Please return by mail. Postage has been provided.

SA	-	Strongly Agree
A	-	Agree
D	-	Disagree
SD	-	Strongly Disagree

**Microgravity - Teacher's Guide With Activities - Secondary Level**

1. The teaching guide is easily integrated into the curriculum.	SA	A	D	SD
2. The procedures for the activities have sufficient information and are easily understood.	SA	A	D	SD
3. The illustrations are adequate to explain the procedures and concepts.	SA	A	D	SD
4. Activities effectively demonstrate concepts and are appropriate for the grade level I teach.	SA	A	D	SD

5. a. What features of the guide are particularly helpful in your teaching?

b. What changes would make the guide more effective for you?

6. I teach \_\_\_\_\_ grade. Subjects \_\_\_\_\_

7. I used the guide with \_\_\_\_\_ (number of ) students.

Additional comments:

